

1/4 SIZE DETAILS

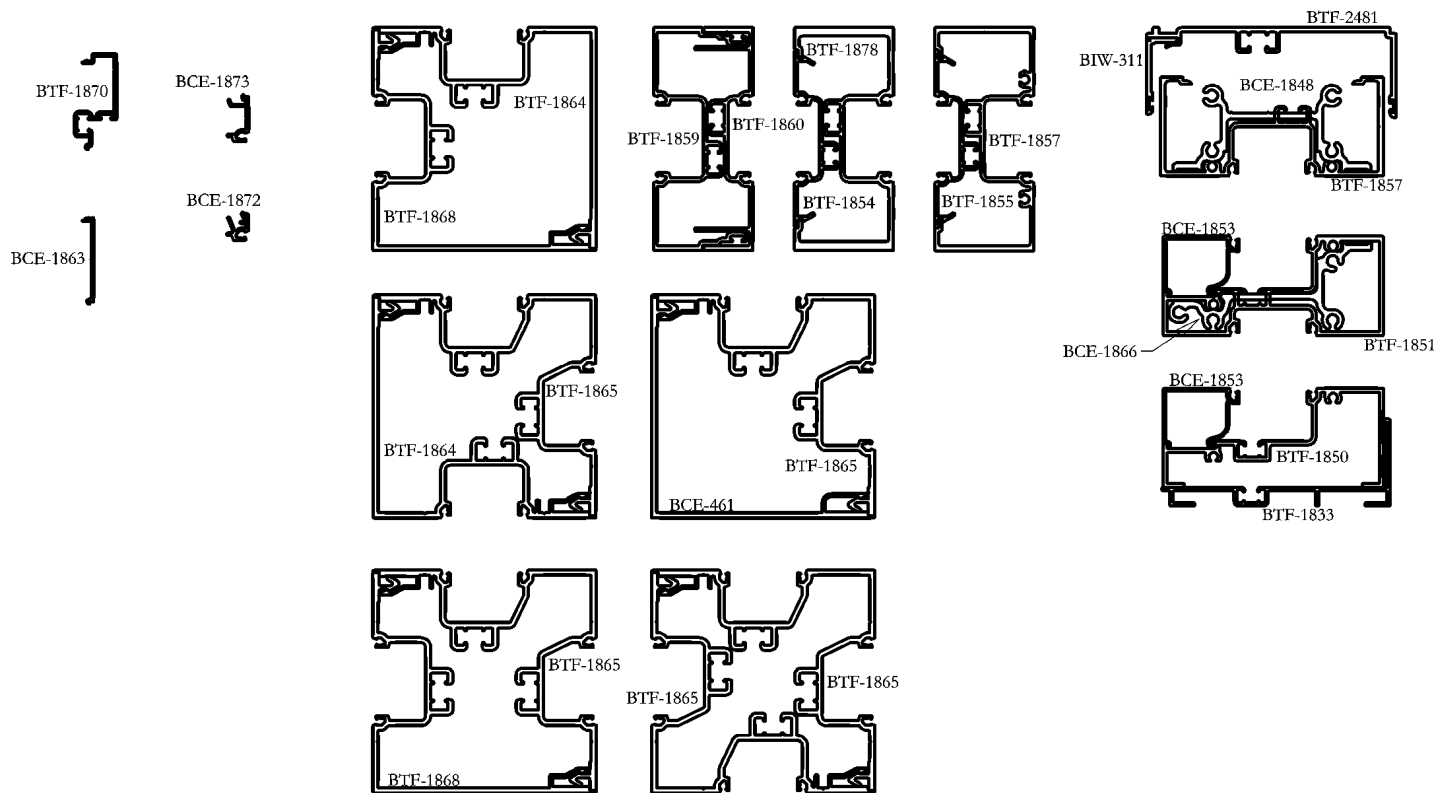

THIS SYSTEM IS DESIGNED TO BE ASSEMBLED WITH #12 SCREWS

GLAZING INFORMATION

REED RUBBER PRODUCTS PH.# 800-325-9698	#3678 #3679 #3680 #4006 #4007	INTERIOR AND EXTERIOR NOMINAL INTERIOR AND EXTERIOR LIGHT INTERIOR AND EXTERIOR HEAVY PERIMETER WIPER GASKET (LIGHT) HEAD PERIMETER GASKET (HEAVY)
TREMCO PH.# 800-321-6357	#TR-2860E	INTERIOR AND EXTERIOR NOMINAL
UNIVERSAL RUBBER COMPANY PH.# 800-782-2375	#3194 #3239	INTERIOR AND EXTERIOR NOMINAL FOR PERIMETERS BTF-2481 AND BIW-311

DOOR PILE





SCHLEGEL CORP. 800-828-6237	AS SELECTED	USED WITH BCE-1870
AMESBURY GROUP INC. 704-878-6892	AS SELECTED	USED WITH BCE-1870

NO TEST DATA AVAILABLE
TREDEGAR EXTRUSIONS INC. DOES NOT MAKE ANY WARRANTY EXPRESS OR IMPLIED INCLUDING
NO WARRANTY OF MERCHANTABILITY OR FITNESS FOR A PARTICULAR PURPOSE AND RESERVES
THE RIGHT TO MAKE CHANGES
REPRODUCTION RIGHTS RESERVED

PRICING FACTORS
2 X 4 1/2 FLUSH GLAZED
BTF-1850 SERIES

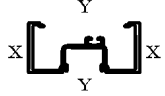
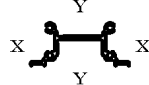
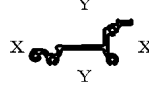

WEIGHT PER FT	EST PER	FACTOR	CAVITY AREA	PART NUMBER	STRUCTURAL VALUES			1/8 SIZE DETAILS
					X-X	Y-Y	I S	
1.049	22.407	21	BBS	BTF1850	0.306	I	1.957	
					0.305	S	0.790	
0.653	17.626	27	BBS	BTF1833	0.077	I	1.311	
					0.056	S	0.493	
1.468	17.286	21	BBS	BTF1851	0.489	I	2.366	
					0.411	S	0.965	
0.498	13.286	27	AA	BTF1854	0.027	I	0.432	
					0.048	S	0.234	
1.366	27.240	20	BB	BTF1857	0.464	I	3.005	
					0.381	S	1.320	
1.130	24.375	22	BBS	BTF1859	0.283	I	2.328	
					0.238	S	1.021	
1.020	21.711	21	BBS	BTF1860	0.082	I	2.082	
					0.108	S	0.912	
1.710	29.370	17	DD	BTF1864	2.364	I	2.941	
					0.746	S	1.011	
2.113	36.454	17	DD (2)	BTF1865	2.866	I	2.857	
					0.973	S	0.968	
1.691	28.902	17	DD	BTF1868	2.846	I	2.325	
					0.968	S	0.730	
0.907	18.071	20	DD	BTF2481	0.131	I	2.046	
					0.086	S	0.713	
1.267	21.440	17	N/A	BCE461	2.454	I	2.503	
					0.770	S	0.791	
0.221	4.608	21	N/A	BIW311	0.004	I	0.043	
					0.008	S	0.045	
0.284	9.065	32	N/A	BCE1853	0.040	I	0.074	
					0.052	S	0.091	

WEIGHT PER FT	EST PER	FACTOR	CAVITY AREA	PART NUMBER	STRUCTURAL VALUES			1/8 SIZE DETAILS
					X-X	I	Y-Y	
0.268	8.845	33	AAS	BTF1870	0.019	I	0.078	
					0.038	S	0.079	
1.710	25.224	15	BBS	BTF1878	0.558	I	4.301	
					0.481	S	1.894	
1.260	17.592	14	N/A	BCE1848	0.275	I	1.379	
					0.297	S	0.690	
1.142	15.885	14	N/A	BCE1866	0.213	I	1.393	
					0.203	S	0.636	
0.125	4.082	33	N/A	BCE1863	0.000	I	0.033	
					0.000	S	0.036	
0.104	3.230	31	N/A	BCE1872	0.001	I	0.002	
					0.004	S	0.006	
0.126	3.999	32	N/A	BCE1873	0.002	I	0.010	
					0.007	S	0.020	

WINDLOAD CHARTS
2 X 4 1/2 FLUSH GLAZED
BTF-1850 SERIES

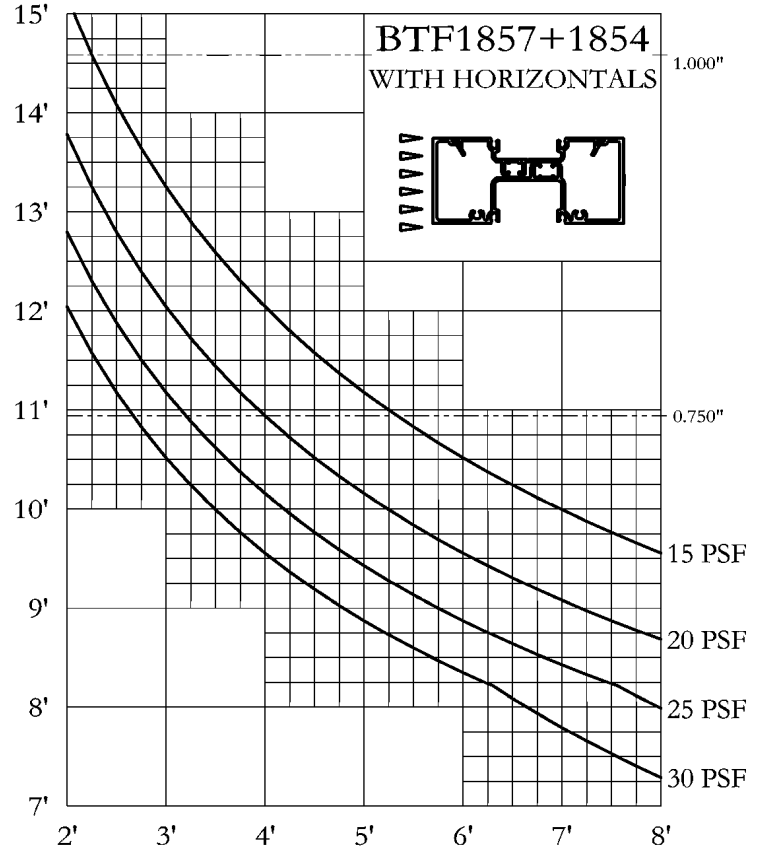
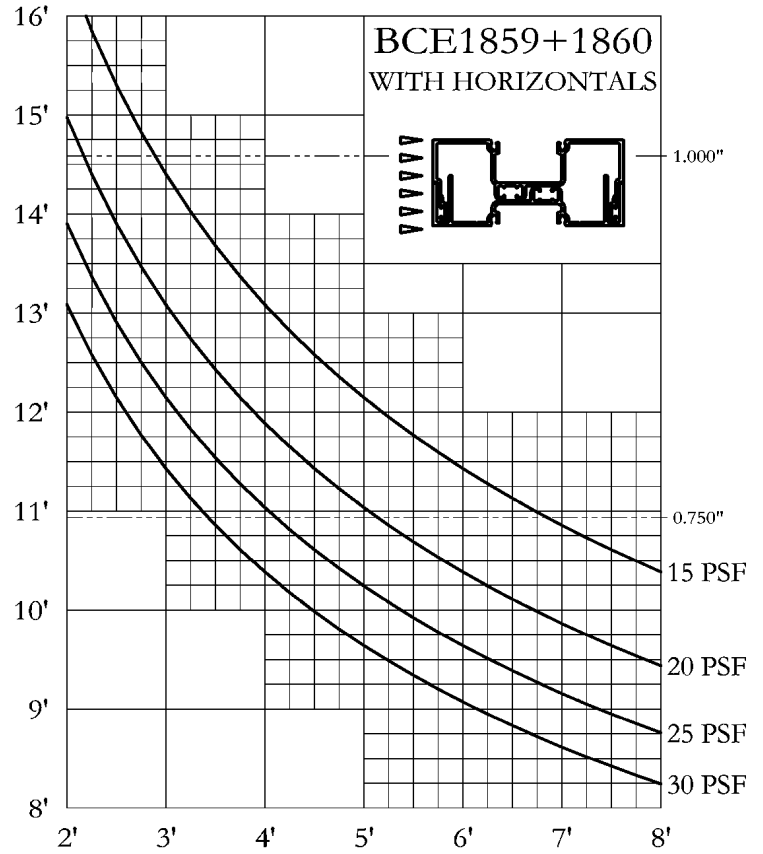
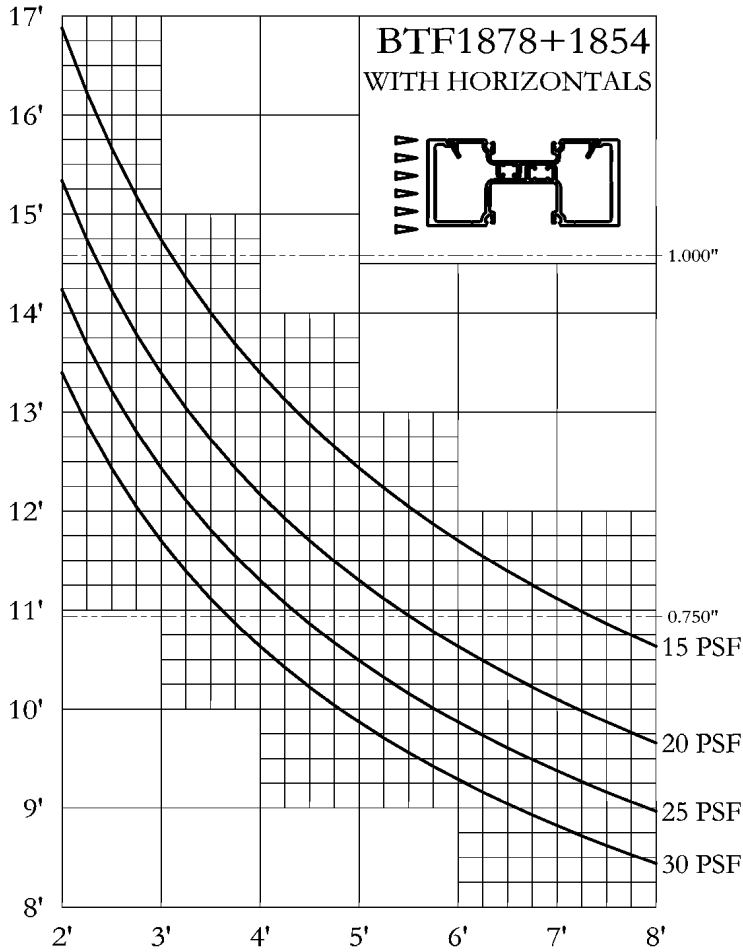

#1 THESE WINDLOAD CHARTS ARE BASED UPON THE LESSER OF DEFLECTION RATIO (L/175) OR STRESS (12667)

#2 THESE STRUCTURAL CURVES ARE ESTIMATES AND ARE PRESENTED TO THE BEST KNOWLEDGE OF THE WILLIAM L BONNELL CO. IT IS, HOWEVER, THE RESPONSIBILITY OF THE CUSTOMER TO BE SATISFIED THAT THE CURVES ARE CORRECT. THE WILLIAM L BONNELL CO. MAY NOT BE HELD RESPONSIBLE IN ANY WAY FOR THE FAILURE OF PERFORMANCE RESULTING FROM THE USE OF THESE CURVES.

FULL SIZE DETAILS

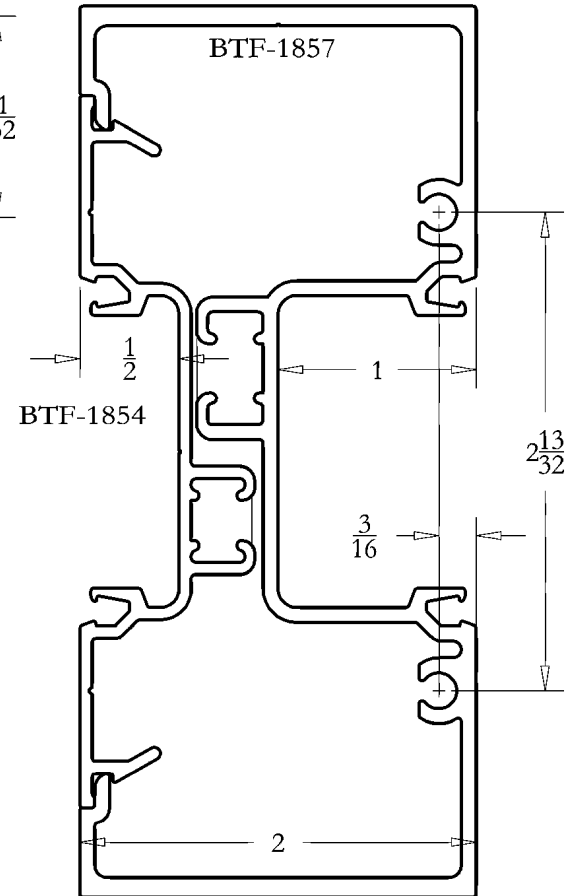
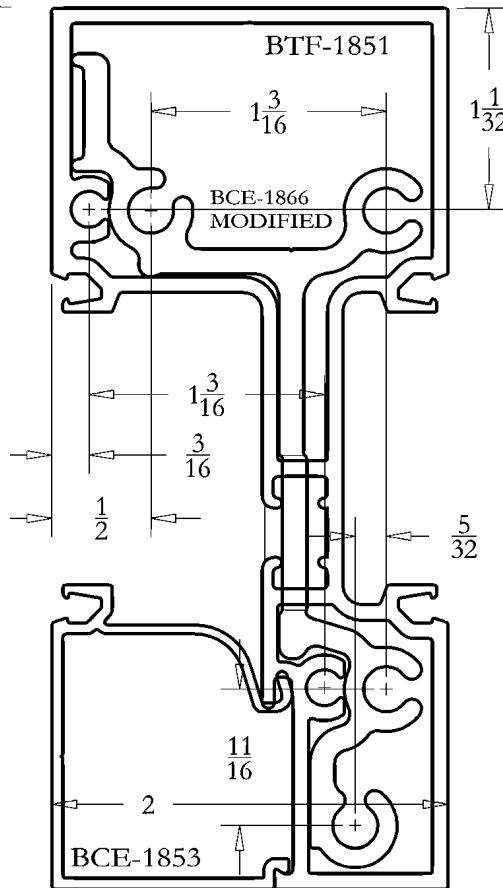
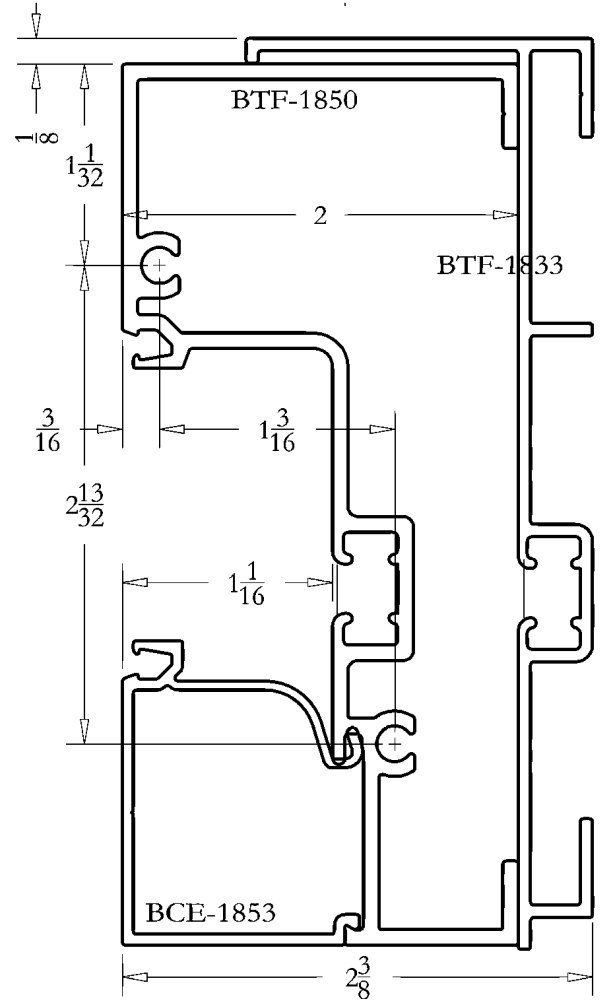
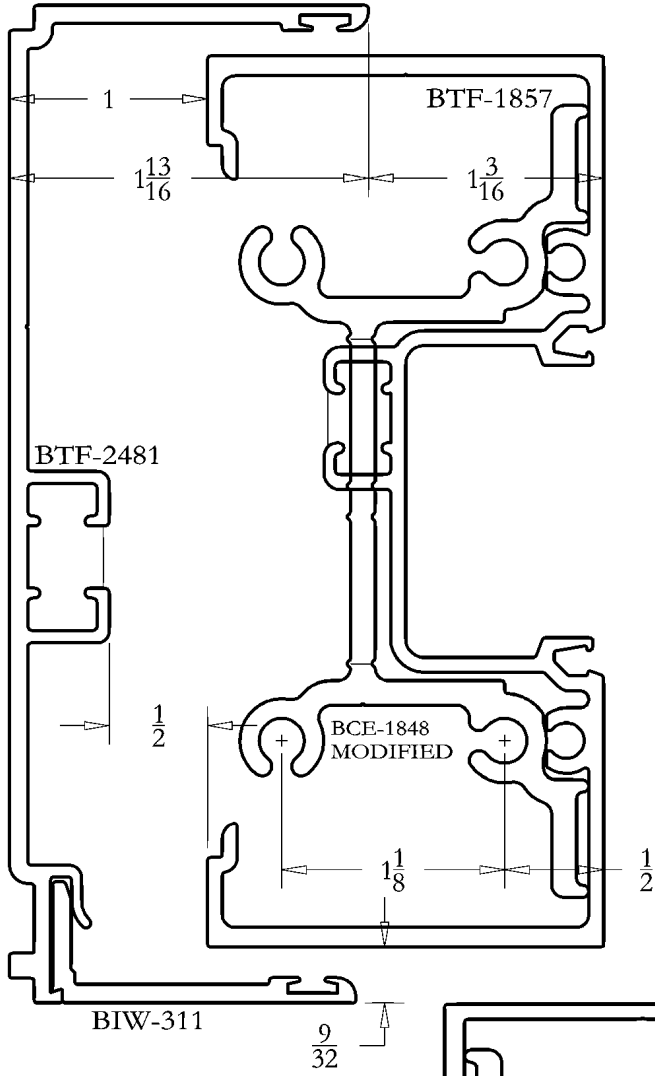

DETAIL SHEET
2 X 4 1/2 FLUSH GLAZED
BTF-1850



FULL SIZE DETAILS

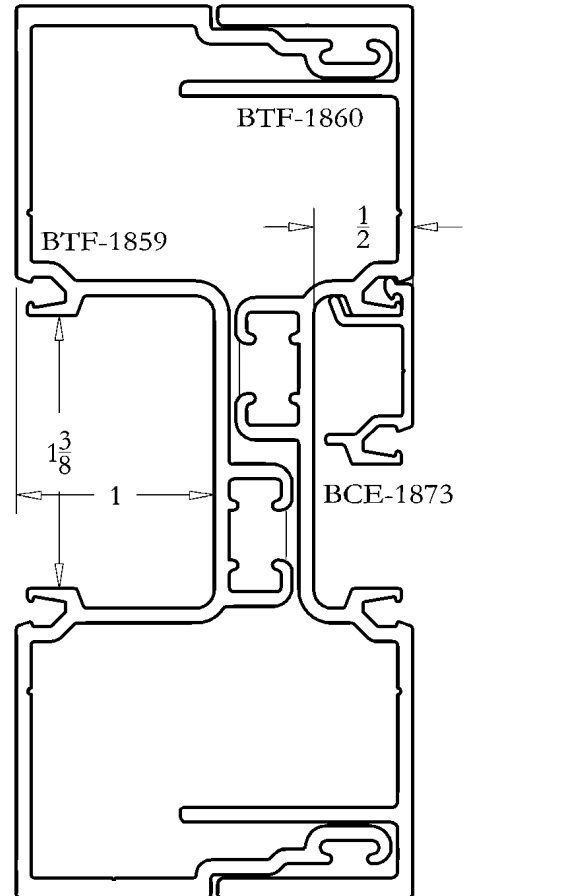
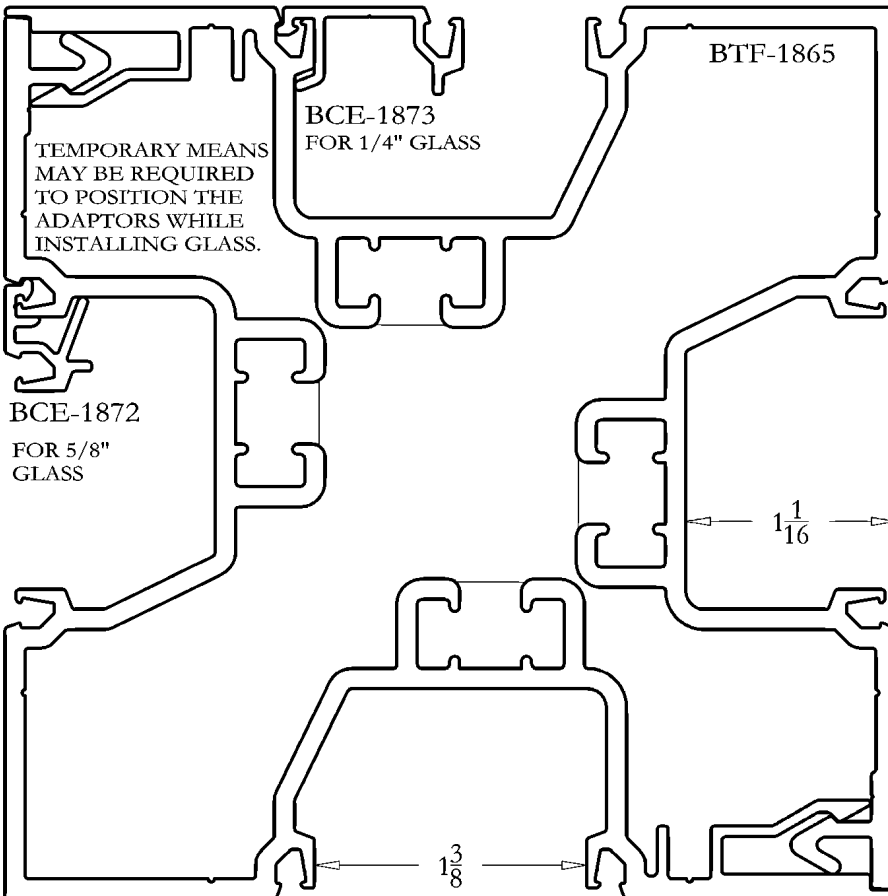
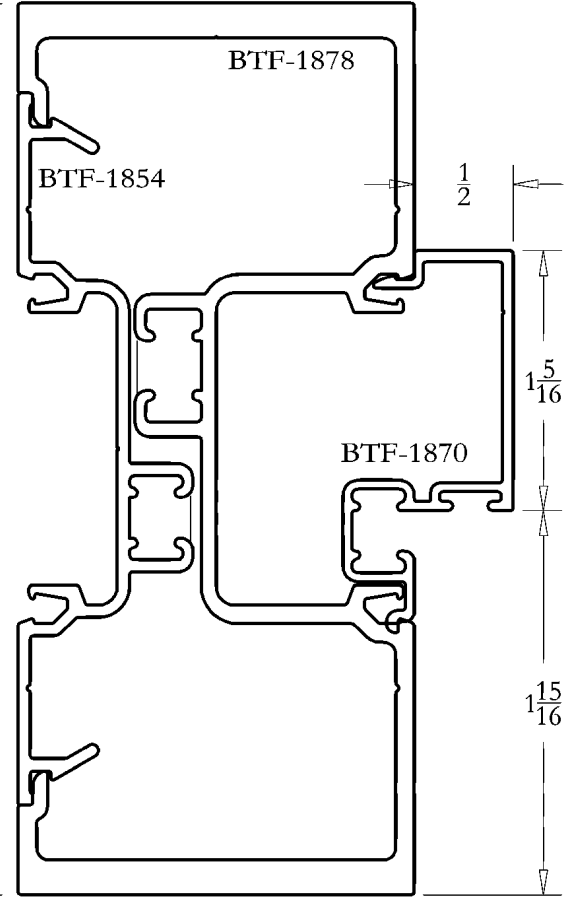
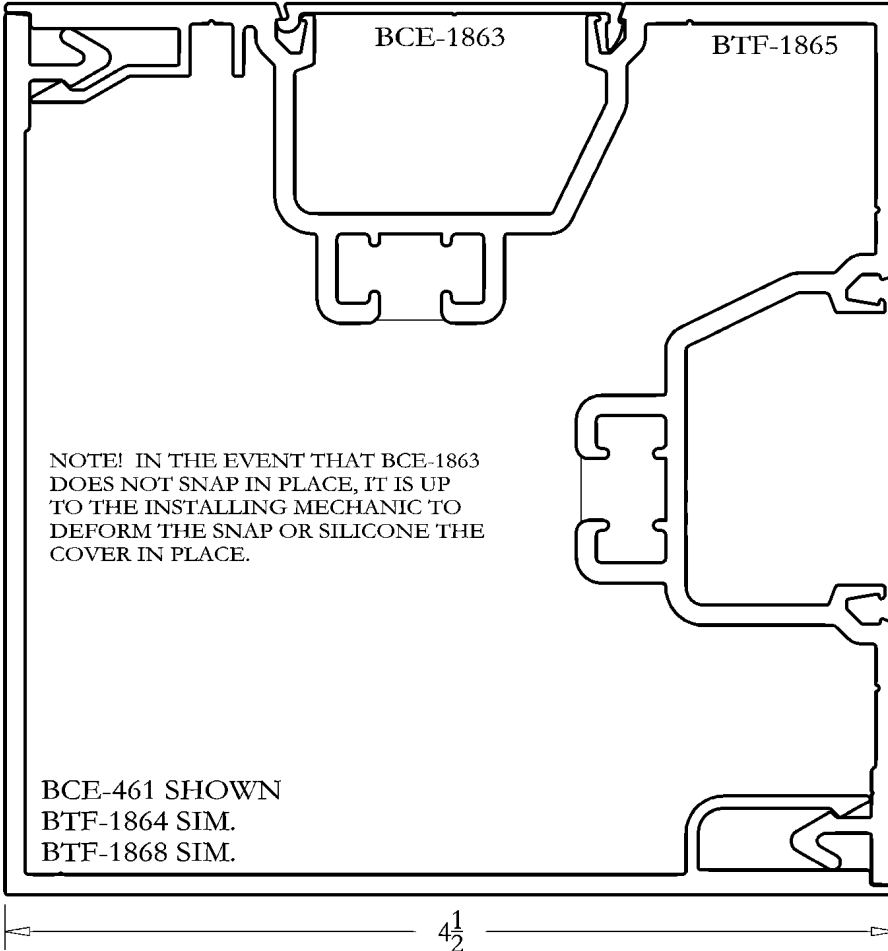

FULL SIZE DETAILS

