

1/4 SIZE DETAILS



THIS SYSTEM IS DESIGNED TO BE ASSEMBLED WITH #12 SCREWS.

GASKET INFORMATION

REED RUBBER COMPANY 800-325-9698	#3678 #3679 #3680	INTERIOR & EXTERIOR (LIGHT) INTERIOR & EXTERIOR (NORMAL) INTERIOR & EXTERIOR (HEAVY)
UNIVERSAL RUBBER CO. 800-782-2375	#3194	INTERIOR & EXTERIOR
TREMCO 800-321-6357	#TR-2860E	INTERIOR & EXTERIOR (NORMAL)
<u>DOOR PILE</u>		
SCHLEGEL CORP. 800-828-6237	AS SELECTED	USED WITH BCE-9314 AND LIKE SHAPES
AMESBURY GROUP INC. 704-878-6892	AS SELECTED	USED WITH BCE-9314 AND LIKE SHAPES

NO TEST DATA AVAILABLE  
 TREDEGAR EXTRUSIONS INC. DOES NOT MAKE ANY WARRANTY EXPRESS OR IMPLIED INCLUDING  
 NO WARRANTY OF MERCHANTABILITY OR FITNESS FOR A PARTICULAR PURPOSE AND RESERVES  
 THE RIGHT TO MAKE CHANGES  
 REPRODUCTION RIGHTS RESERVED

**PRICING FACTORS**  
**1 3/4" x 4 1/2" FLUSH GLAZED**  
**BCE-9200 SERIES**

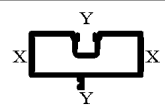
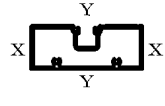
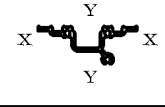
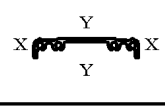
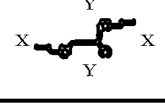
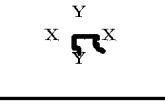
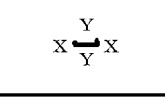
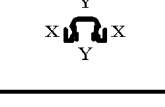
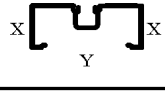
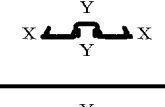
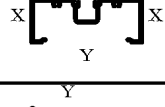
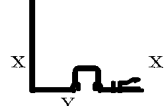
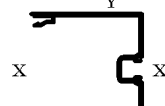
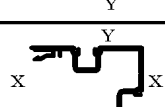

WEIGHT PER FT	EST PER	FACTOR	CAVITY AREA	PART NUMBER	STRUCTURAL VALUES			1/8 SIZE DETAILS
					X-X	I	Y-Y	
0.474	12.592	27	N/A	BCE114	0.006	I	1.116	
					0.010	S	0.374	
1.267	21.440	17	N/A	BCE461	2.454	I	2.503	
					0.770	S	0.791	
1.267	13.834	17	N/A	BCE1867	2.454	I	2.503	
					0.770	S	0.791	
0.328	8.836	27	N/A	BCE1876	0.002	I	0.366	
					0.006	S	0.204	
1.567	17.169	20	N/A	BCE9200	0.569	I	2.656	
					0.641	S	1.180	
1.043	20.126	19	N/A	BCE9201	0.273	I	2.043	
					0.293	S	0.824	
1.494	15.304	19	N/A	BCE9202	0.429	I	2.303	
					0.413	S	0.958	
0.284	8.976	32	N/A	BCE9204	0.027	I	0.114	
					0.039	S	0.116	
1.768	13.415	15	N/A	BCE9205	0.828	I	3.273	
					0.867	S	1.464	
1.499	15.196	19	N/A	BCE9206	0.585	I	2.853	
					0.663	S	1.268	
0.878	18.771	21	N/A	BCE9207	0.149	I	1.909	
					0.132	S	0.848	
0.938	19.564	21	N/A	BCE9208	0.072	I	1.805	
					0.108	S	0.802	
1.712	14.570	15	N/A	BCE9209	0.861	I	3.122	
					0.640	S	1.382	
1.441	15.304	19	N/A	BCE9212	0.423	I	2.245	
					0.405	S	0.925	

WEIGHT PER FT	EST PER	FACTOR	CAVITY AREA	PART NUMBER	STRUCTURAL VALUES			1/8 SIZE DETAILS
					X-X	I	Y-Y	
1.577	16.702	19	N/A	BCE9251	0.667	I	2.856	
					0.503	S	1.264	
1.601	15.181	19	N/A	BCE9252	0.627	I	2.837	
					0.673	S	1.261	
1.181	15.419	13	N/A	BCE9300	0.177	I	1.006	
					0.175	S	0.476	
1.104	14.085	13	N/A	BCE9301	0.027	I	1.849	
					0.048	S	0.875	
1.084	14.579	13	N/A	BCE9302	0.195	I	0.906	
					0.241	S	0.415	
0.174	5.679	33	N/A	BCE9314	0.007	I	0.024	
					0.015	S	0.035	
0.079	2.581	33	N/A	BCE9315	0.000	I	0.007	
					0.000	S	0.013	
0.340	9.642	28	N/A	BCE9316	0.026	I	0.079	
					0.051	S	0.097	
1.093	22.260	20	N/A	BCE9330	0.315	I	2.527	
					0.284	S	1.123	
0.434	11.593	27	N/A	BCE9332	0.013	I	0.383	
					0.034	S	0.213	
1.190	23.789	20	N/A	BCE9333	0.333	I	2.655	
					0.291	S	1.180	
1.495	25.838	17	N/A	BCE9345	2.468	I	2.661	
					0.759	S	0.879	
1.477	25.334	17	N/A	BCE9346	2.638	I	2.437	
					0.873	S	0.746	
1.726	30.046	17	N/A	BCE9349	2.692	I	2.705	
					0.865	S	0.870	

PRICING FACTORS  
1 3/4" x 4 1/2" FLUSH GLAZED  
BCE-9200 SERIES



WEIGHT PER FT	EST PER	FACTOR	CAVITY AREA	PART NUMBER	STRUCTURAL VALUES			1/8 SIZE DETAILS
					X-X	I	Y-Y	
0.181	5.808	32	N/A	BCE9370	0.005	I	0.019	
					0.013	S	0.030	
1.368	12.473	18	N/A	A9342	0.640	I	2.853	
					0.731	S	1.268	
1.967	17.973	18	N/A	A7047	5.308	I	5.308	
					2.359	S	2.359	
2.626	17.973	13	N/A	A7043	6.984	I	6.984	
					3.104	S	3.104	

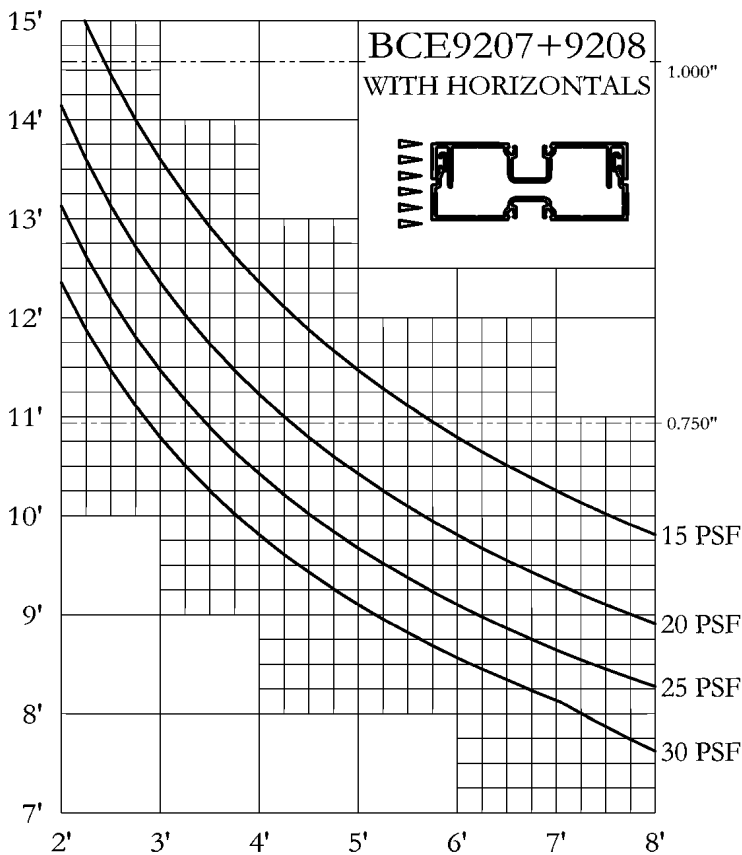
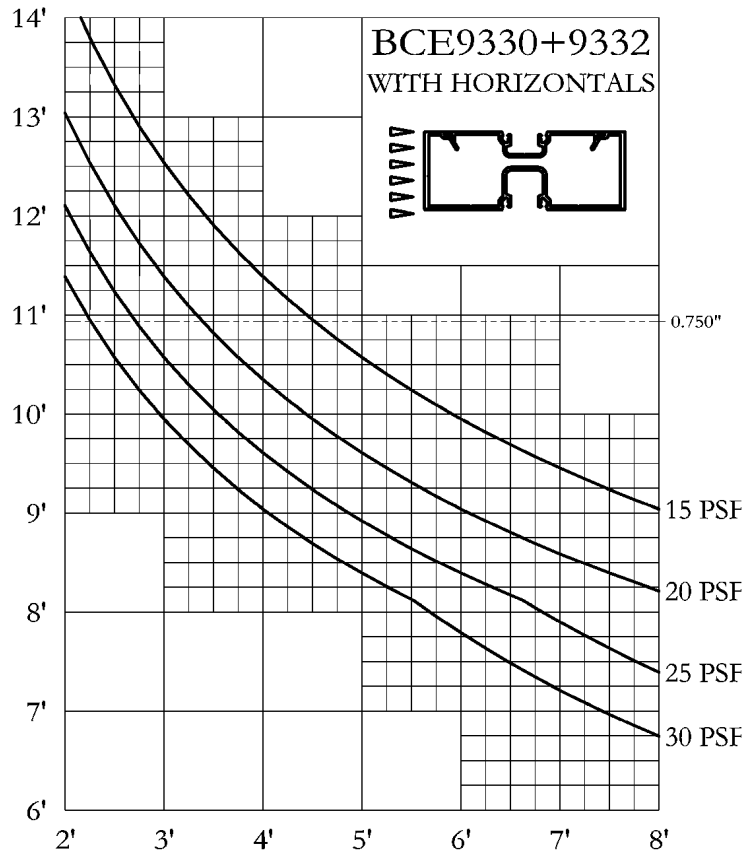
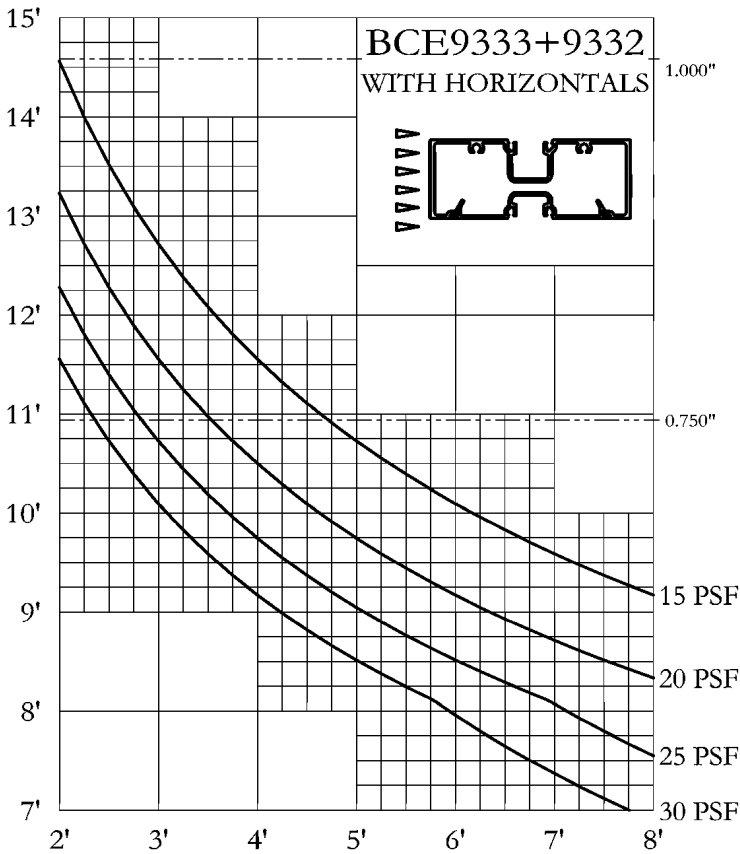

#1 THESE WINDLOAD CHARTS ARE BASED UPON THE LESSER OF DEFLECTION RATIO (L/175) OR STRESS (12667)

#2 THESE STRUCTURAL CURVES ARE ESTIMATES AND ARE PRESENTED TO THE BEST KNOWLEDGE OF THE WILLIAM L BONNELL CO. IT IS, HOWEVER, THE RESPONSIBILITY OF THE CUSTOMER TO BE SATISFIED THAT THE CURVES ARE CORRECT. THE WILLIAM L BONNELL CO. MAY NOT BE HELD RESPONSIBLE IN ANY WAY FOR THE FAILURE OF PERFORMANCE RESULTING FROM THE USE OF THESE CURVES.

WINDLOAD CHARTS  
1 3/4" x 4 1/2" FLUSH GLAZED  
BCE-9200 SERIES

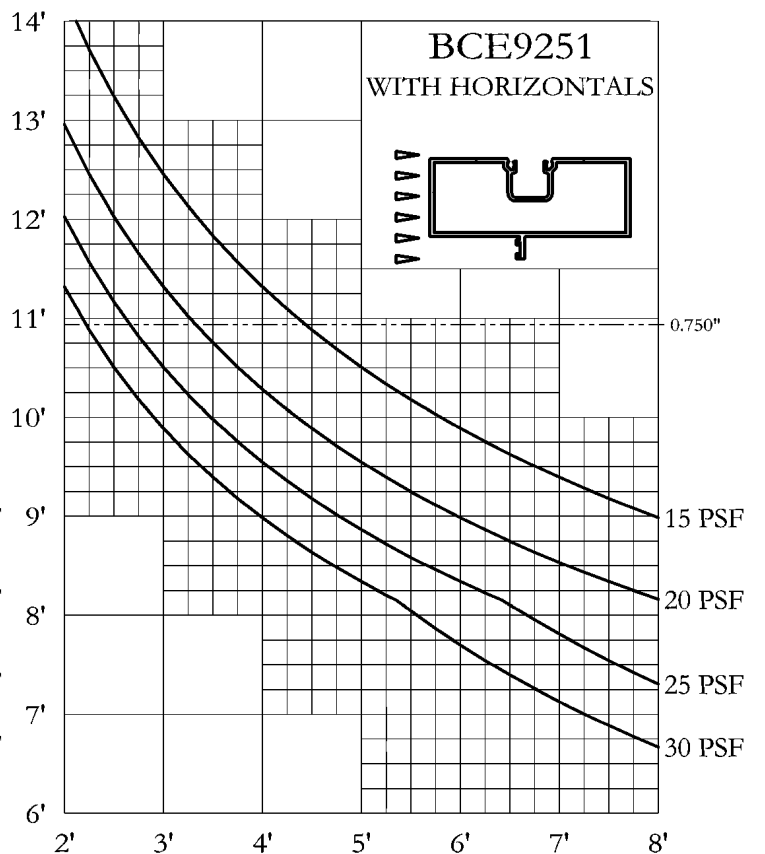
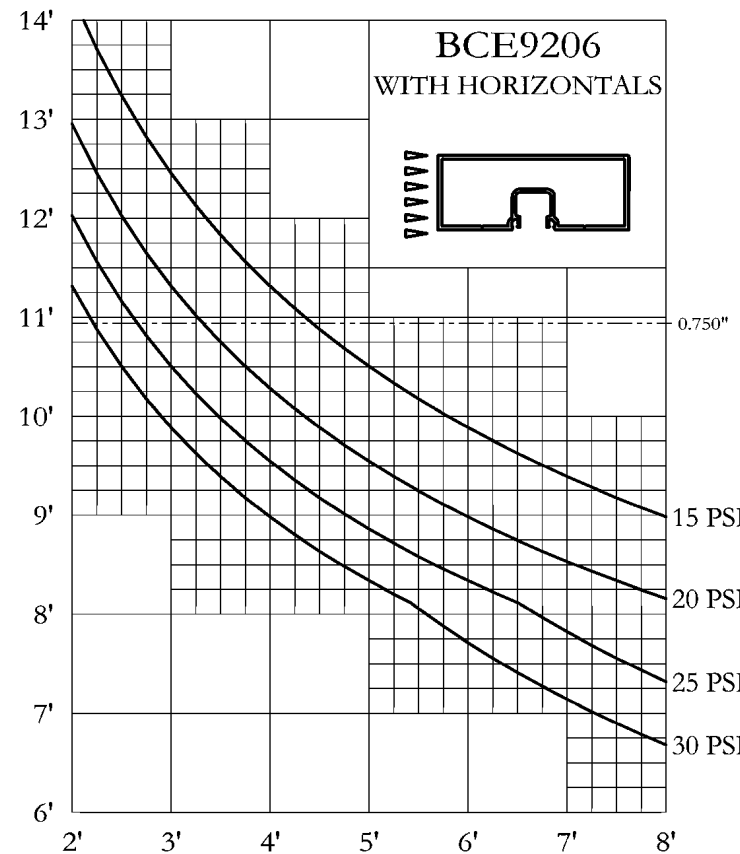
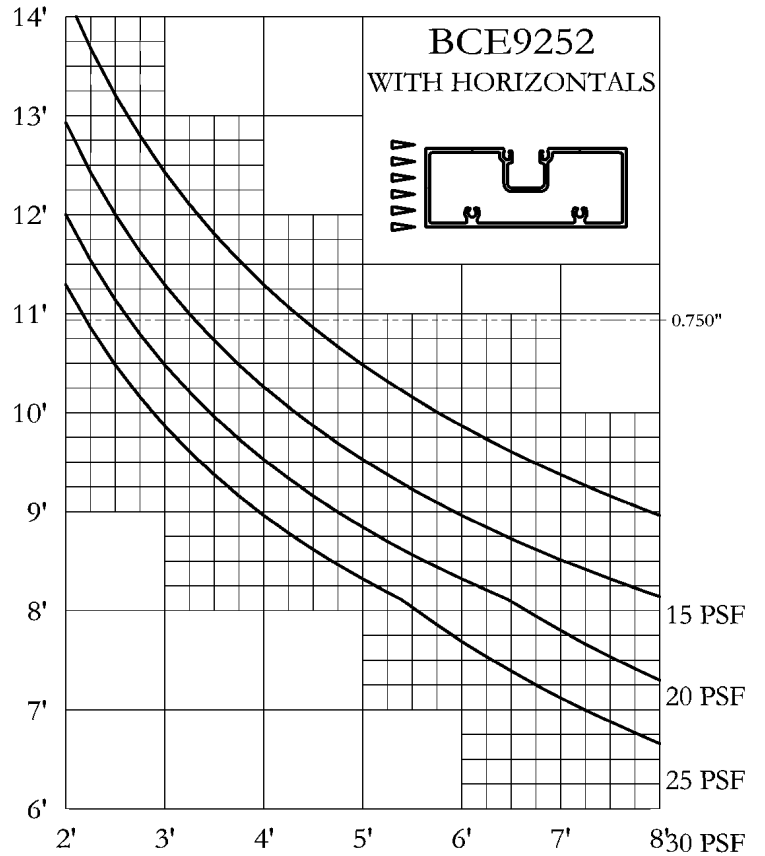
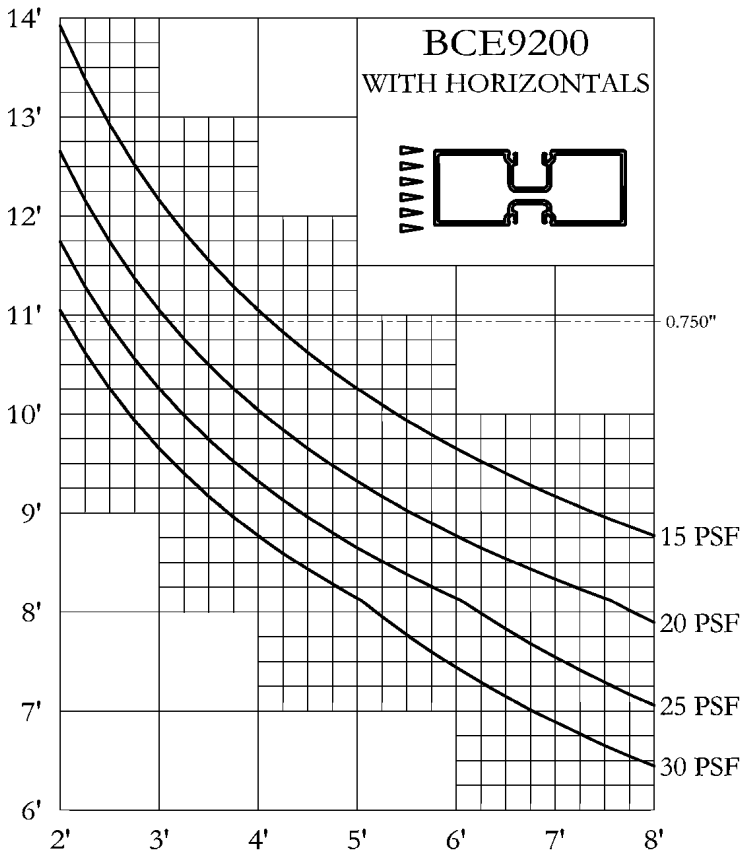

#1 THESE WINDLOAD CHARTS ARE BASED UPON THE LESSER OF DEFLECTION RATIO (L/175) OR STRESS (12667)

#2 THESE STRUCTURAL CURVES ARE ESTIMATES AND ARE PRESENTED TO THE BEST KNOWLEDGE OF THE WILLIAM L BONNELL CO. IT IS, HOWEVER, THE RESPONSIBILITY OF THE CUSTOMER TO BE SATISFIED THAT THE CURVES ARE CORRECT. THE WILLIAM L BONNELL CO. MAY NOT BE HELD RESPONSIBLE IN ANY WAY FOR THE FAILURE OF PERFORMANCE RESULTING FROM THE USE OF THESE CURVES.

FULL SIZE DETAILS

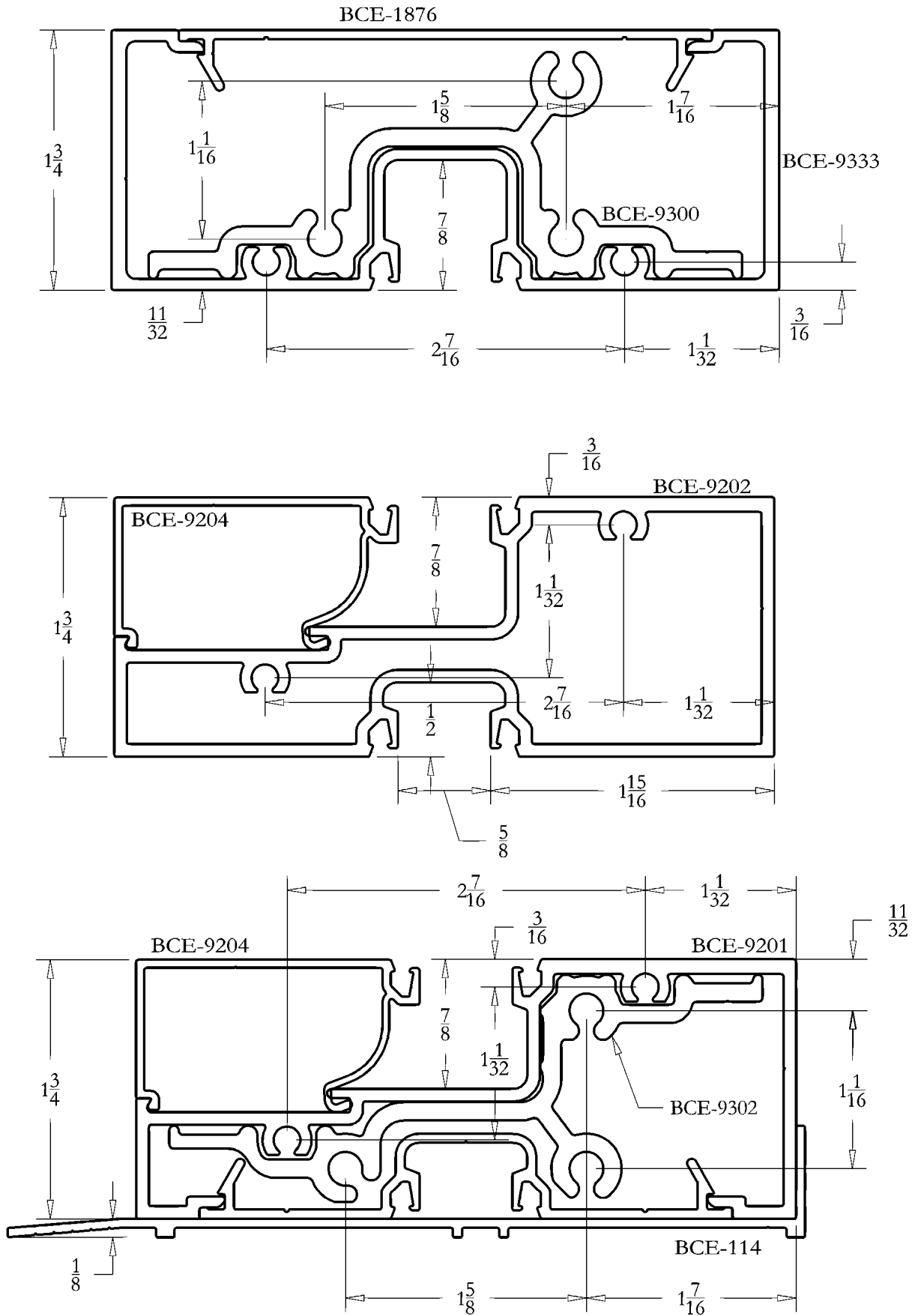

DETAIL SHEET  
1 3/4" x 4 1/2" FLUSH GLAZED  
BCE-9200 SERIES

FULL SIZE DETAILS

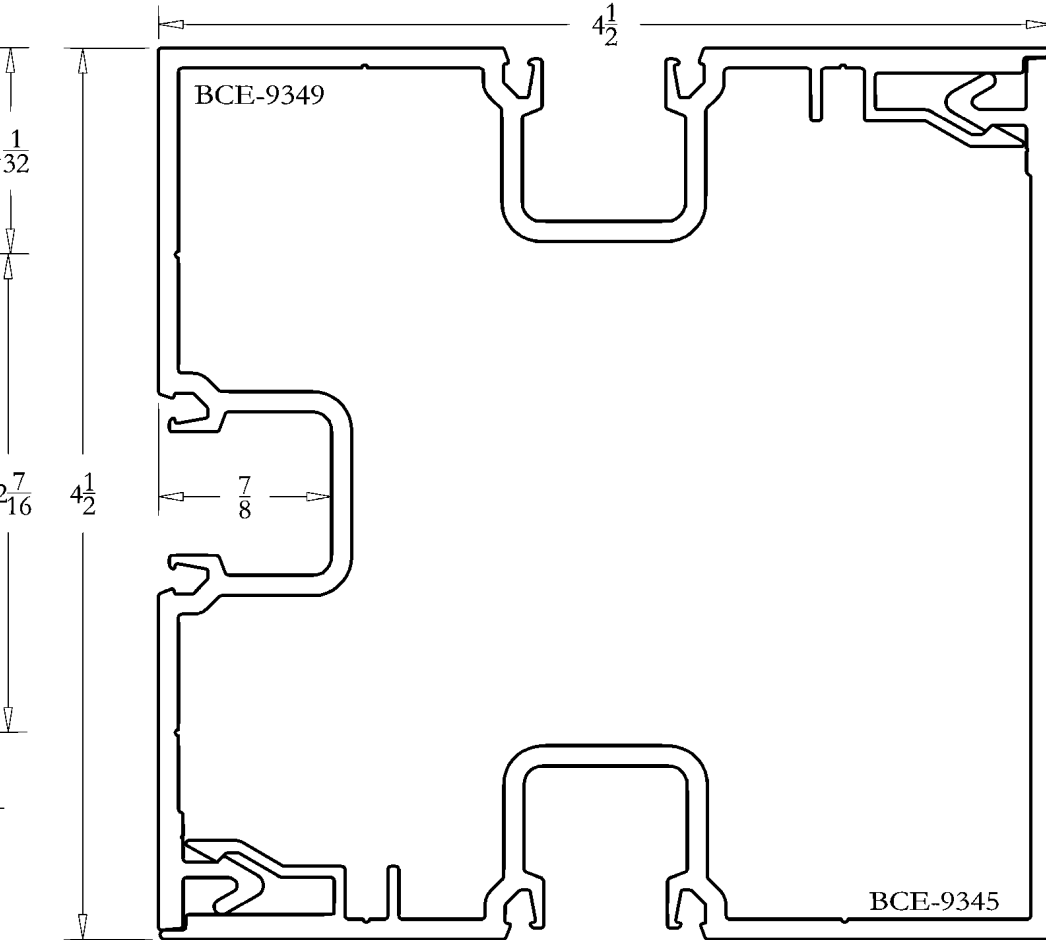
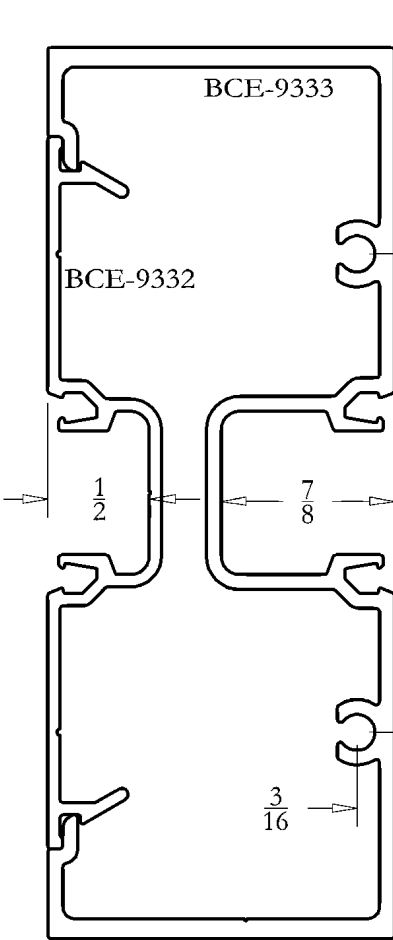
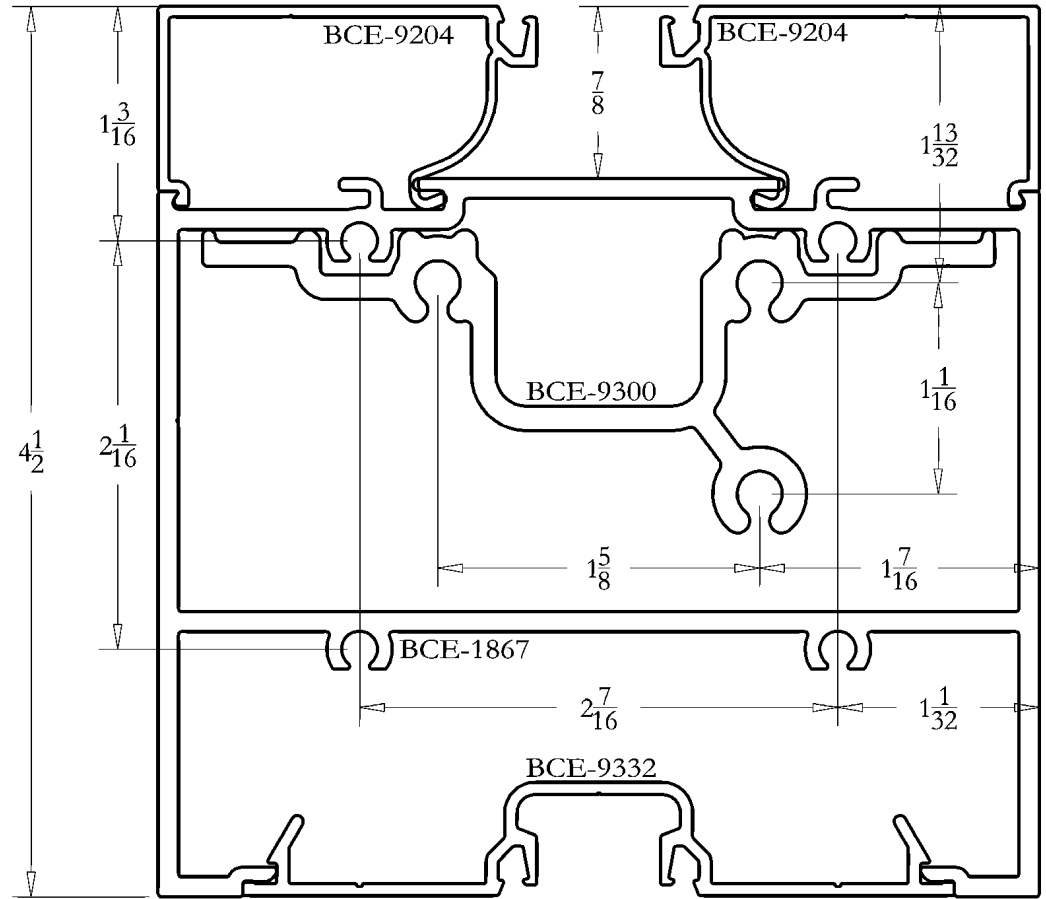
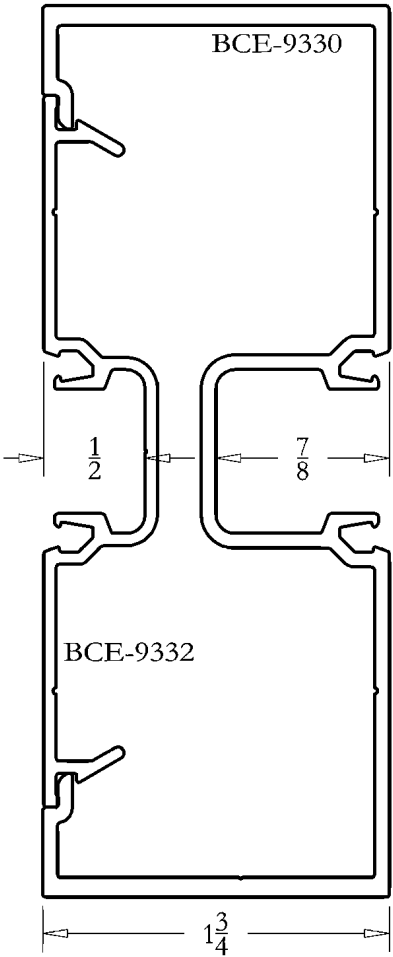



FULL SIZE DETAILS

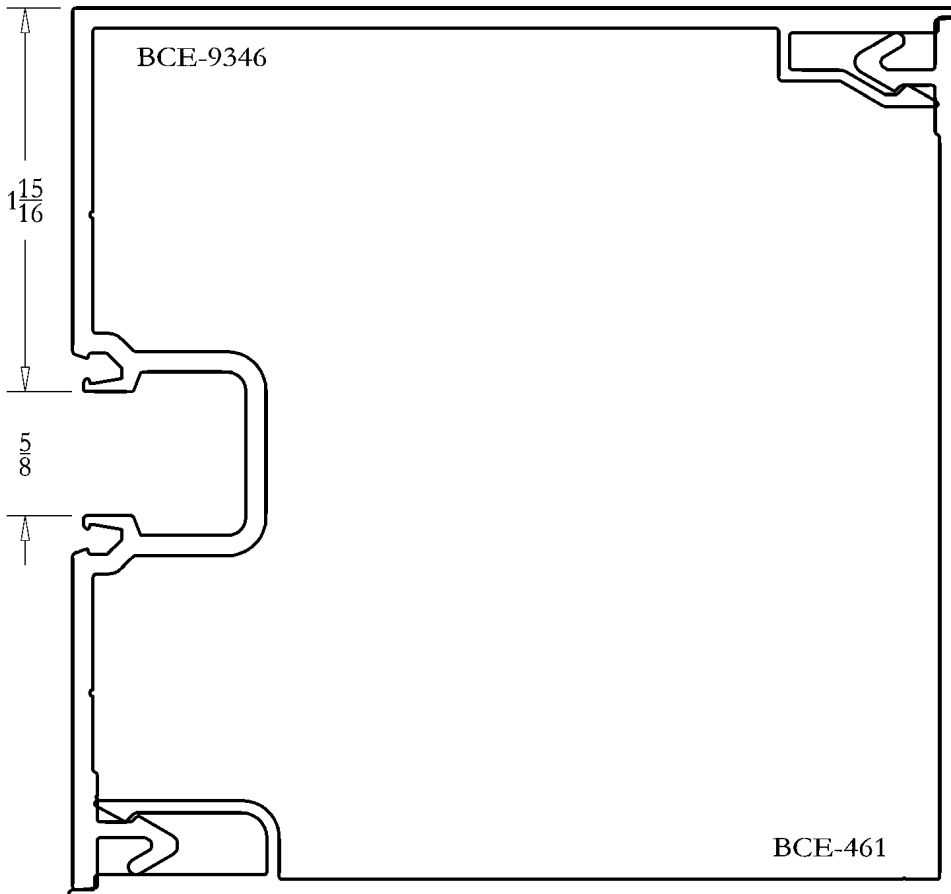
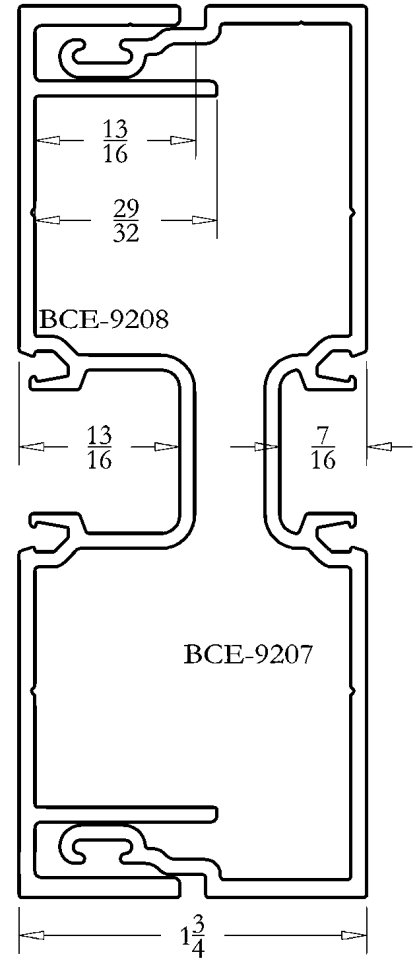
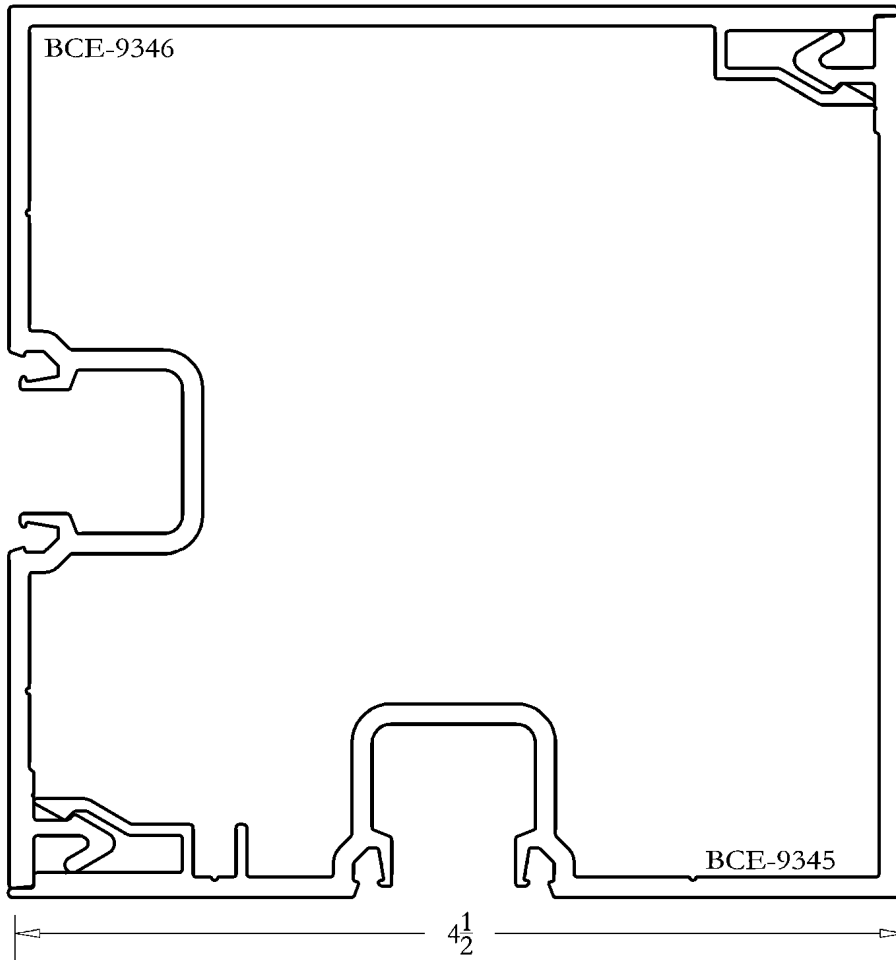

DETAIL SHEET  
1 3/4" x 4 1/2" FLUSH GLAZED  
BCE-9200 SERIES



FULL SIZE DETAILS

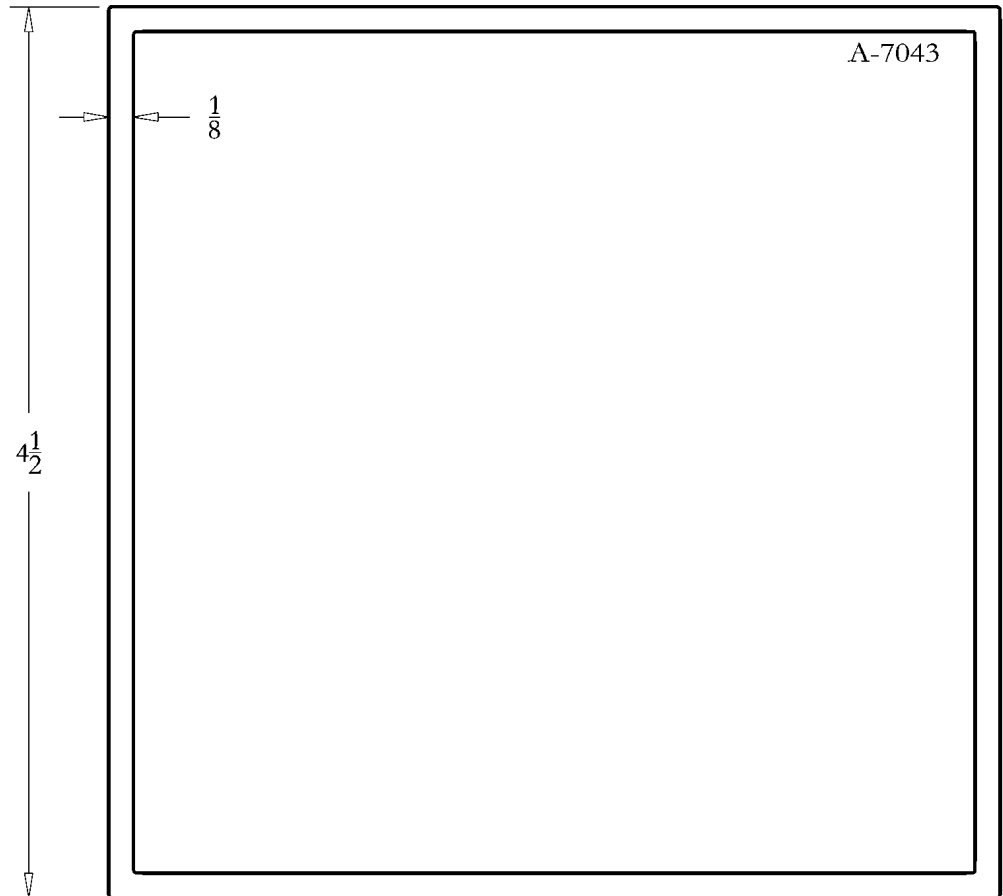
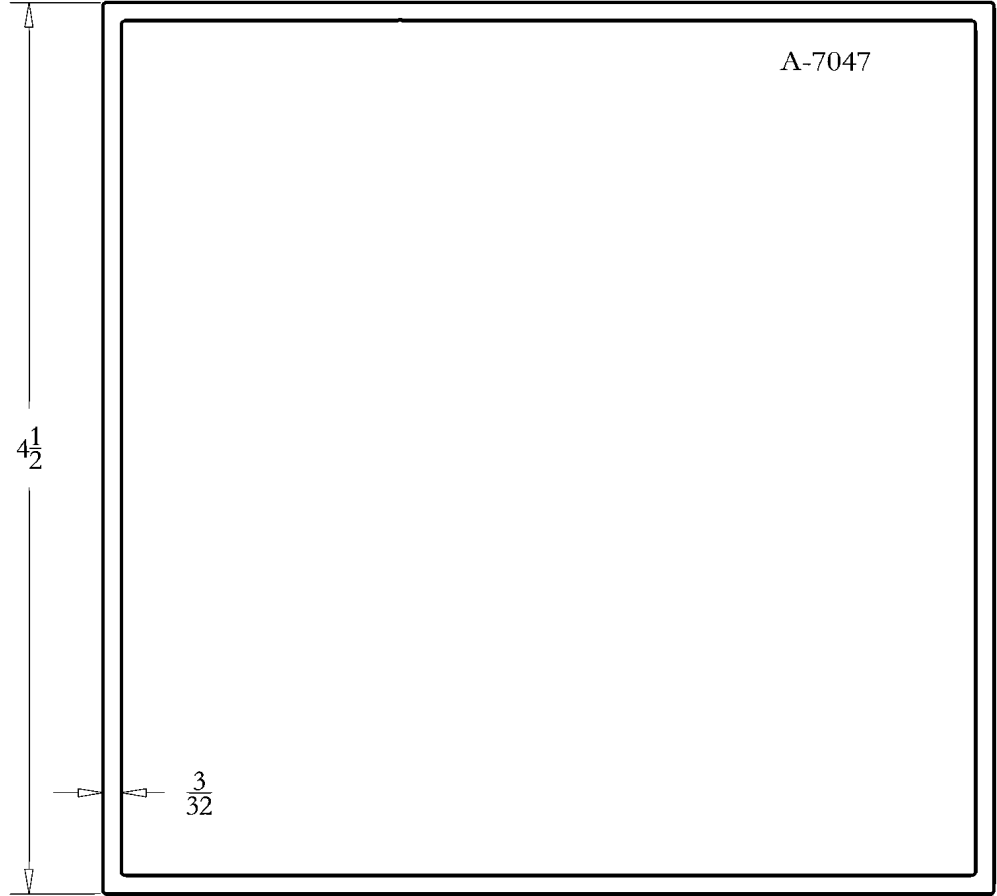
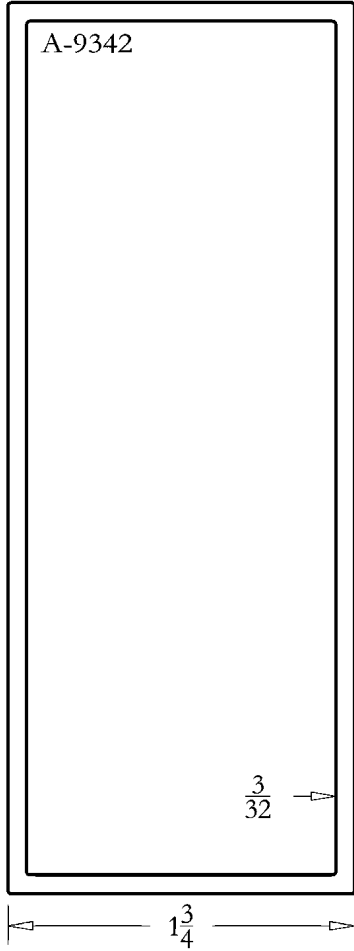

FULL SIZE DETAILS

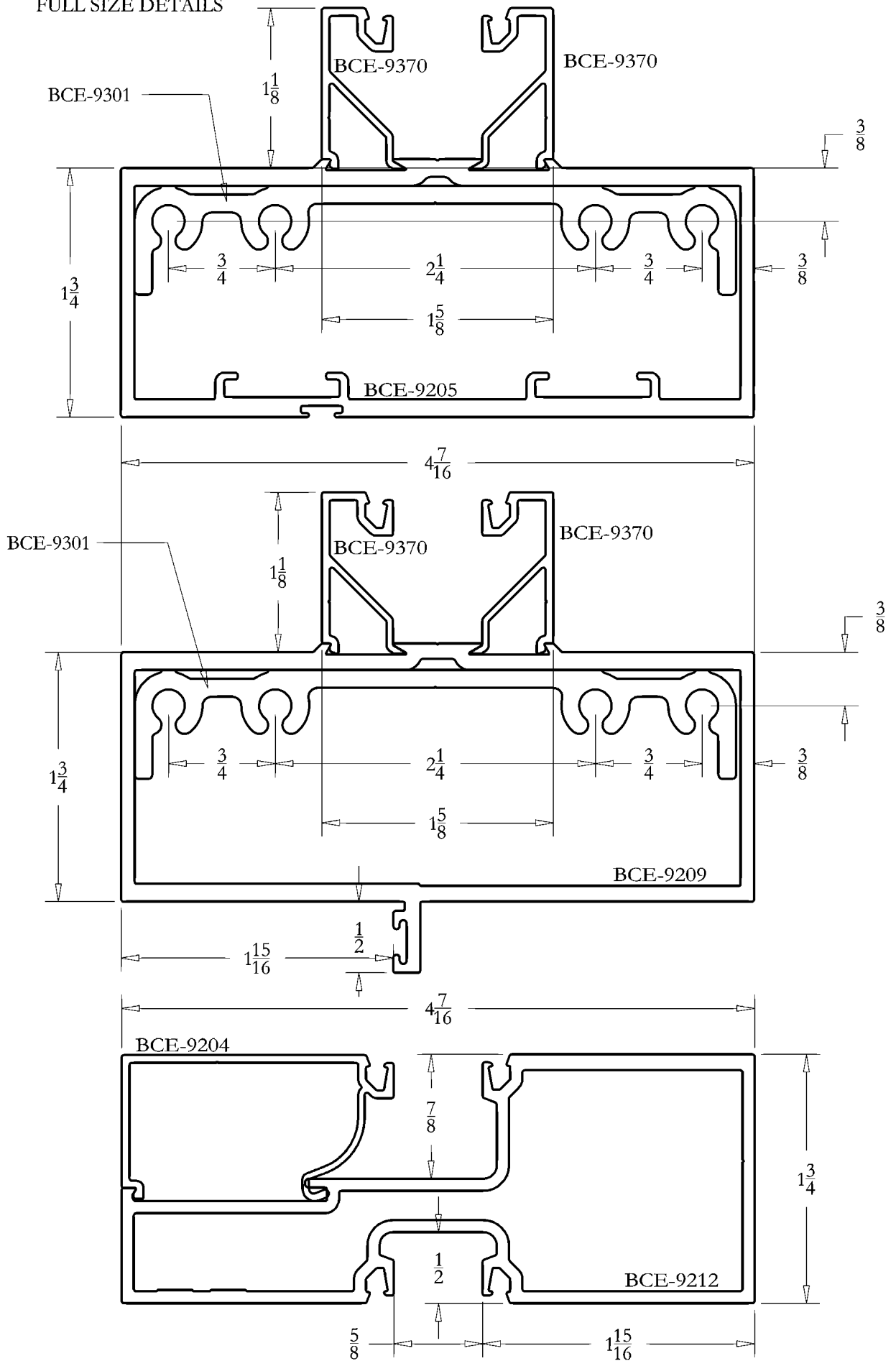

DETAIL SHEET  
1 3/4" x 4 1/2" FLUSH GLAZED  
BCE-9200 SERIES

FULL SIZE DETAILS

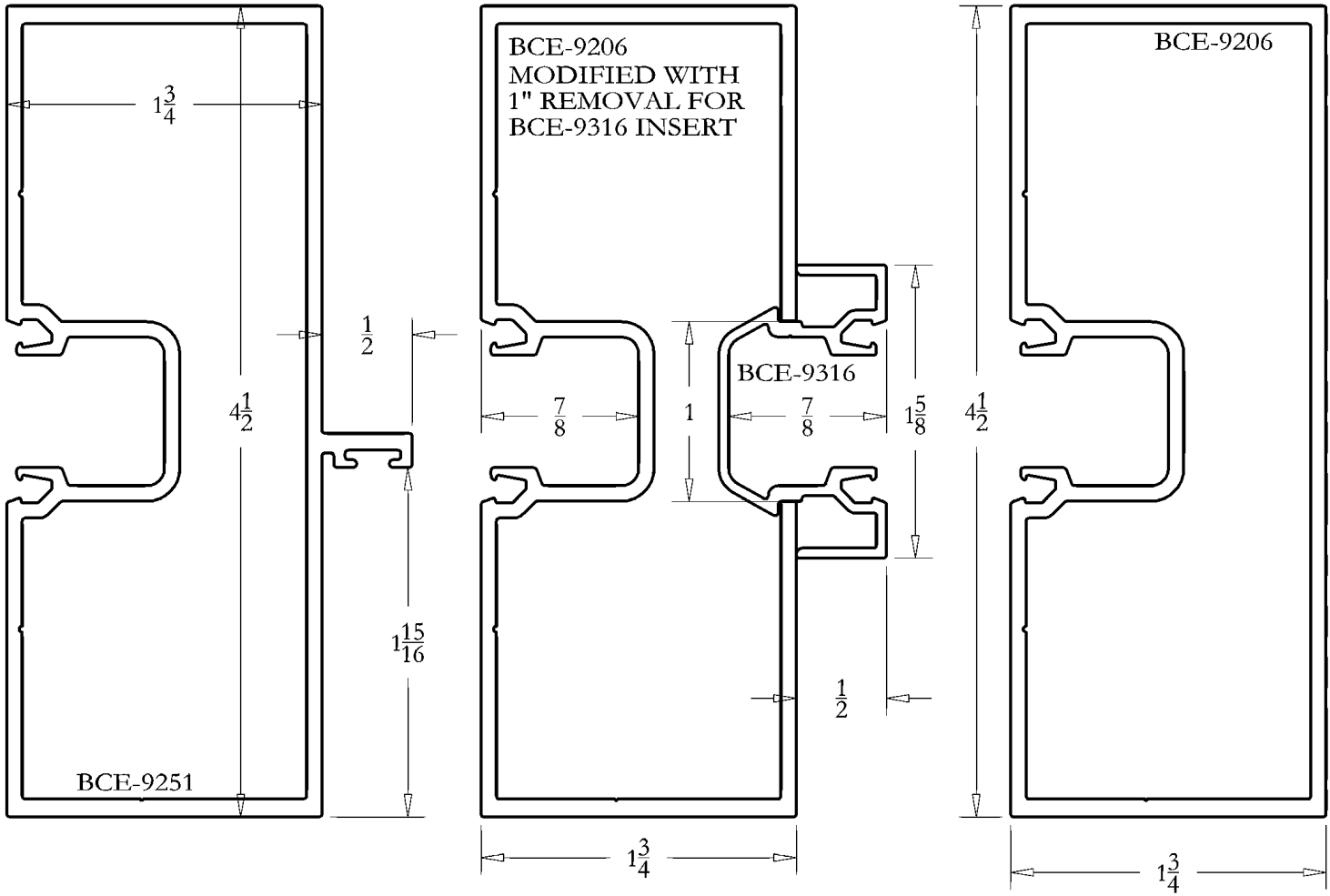

NOTE: IN THE EVENT THAT BCE-9315 DOES NOT SNAP INTO PLACE, IT IS UP TO THE INSTALLING MECHANIC TO DEFORM THE SNAP OR SILICONE THE COVER IN PLACE.

