

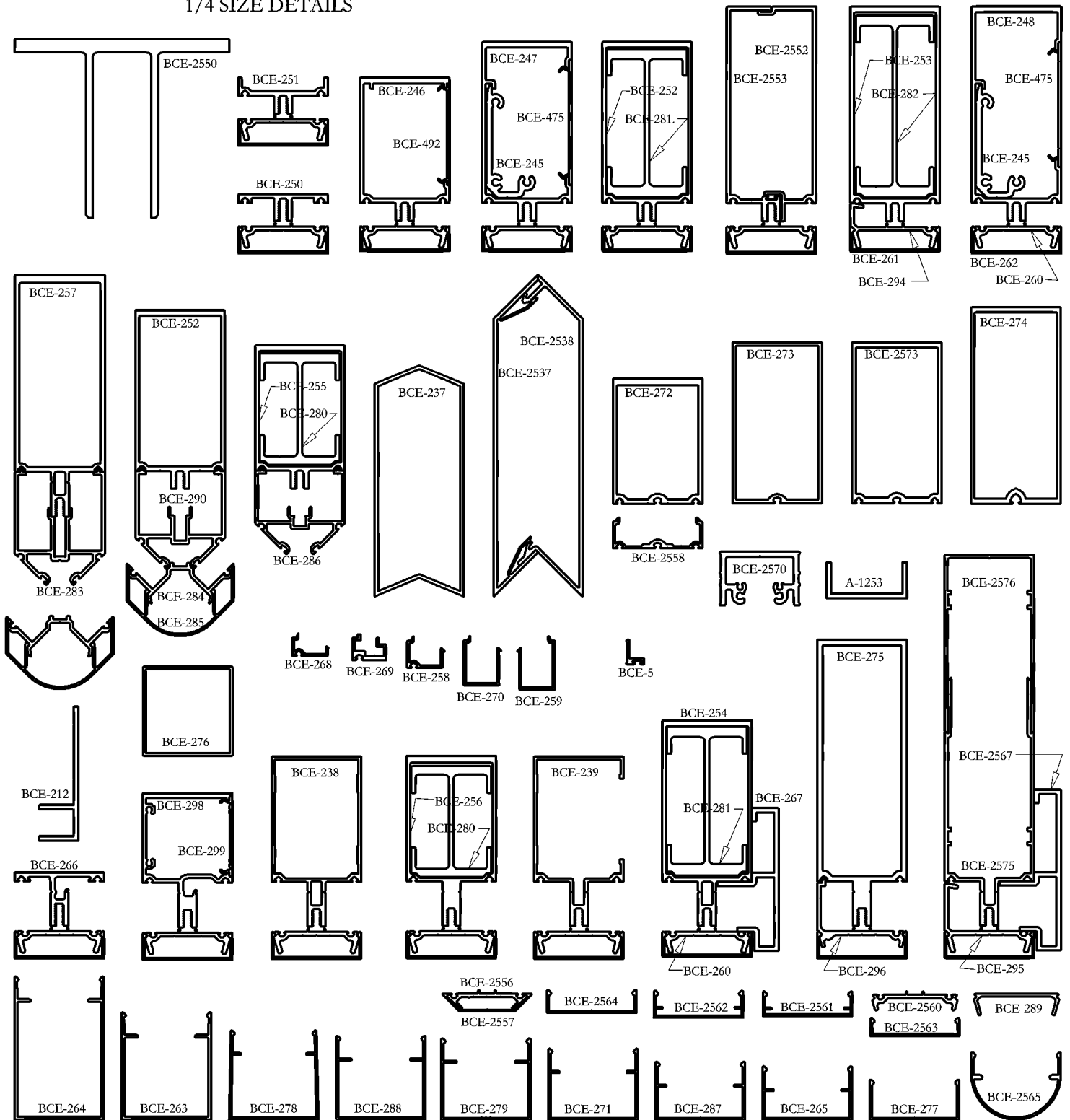

1/4 SIZE DETAILS







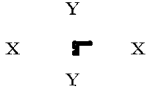
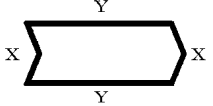
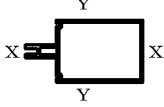
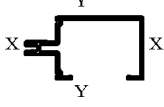
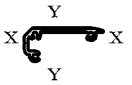
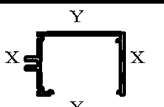
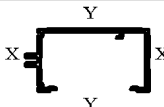
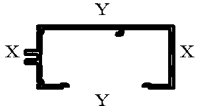

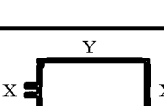
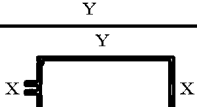
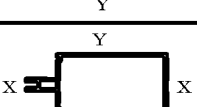
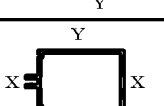
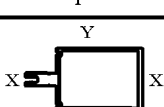
SEE PAGE 14 FOR GASKET INFORMATION.

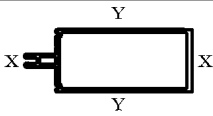
NO TEST DATA AVAILABLE
 TREDEGAR EXTRUSIONS INC. DOES NOT MAKE ANY WARRANTY EXPRESS OR IMPLIED INCLUDING
 NO WARRANTY OF MERCHANTABILITY OR FITNESS FOR A PARTICULAR PURPOSE AND RESERVES
 THE RIGHT TO MAKE CHANGES
 REPRODUCTION RIGHTS RESERVED

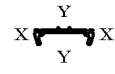
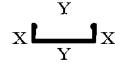
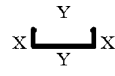
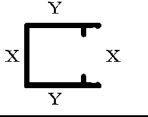
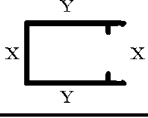
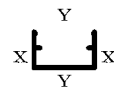
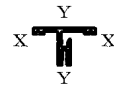
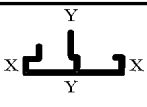

PRICING FACTORS
2 1/2" PRESSURE SYSTEM
BCE-250

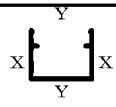
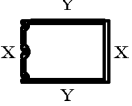
WEIGHT PER FT	EST PER	FACTOR	CAVITY AREA	PART NUMBER	STRUCTURAL VALUES			1/8 SIZE DETAILS
					X-X		Y-Y	
0.109	2.712	25	N/A	BCE5	0.002	I	0.004	
					0.006	S	0.009	
2.027	17.289	17	N/A	BCE237	1.935	I	7.802	
					1.548	S	2.297	
1.638	16.567	18	N/A	BCE238	1.102	I	3.249	
					0.882	S	1.351	
1.370	24.887	18	N/A	BCE239	0.770	I	3.037	
					0.529	S	1.219	
1.004	11.469	11	N/A	BCE245	0.123	I	0.847	
					0.122	S	0.428	
1.504	21.167	14	N/A	BCE246	0.848	I	2.968	
					0.560	S	1.428	
1.732	24.940	14	N/A	BCE247	1.083	I	5.334	
					0.709	S	2.034	
1.972	28.940	15	N/A	BCE248	1.384	I	8.529	
					0.926	S	2.750	
0.632	9.611	15	N/A	BCE250	0.022	I	0.226	
					0.040	S	0.181	
0.648	9.599	15	N/A	BCE251	0.023	I	0.280	
					0.044	S	0.224	
2.041	17.048	15	N/A	BCE252	1.593	I	5.492	
					1.274	S	2.099	
2.281	19.048	15	N/A	BCE253	1.881	I	8.726	
					1.505	S	2.807	
2.254	18.623	15	N/A	BCE254	1.597	I	7.090	
					1.278	S	2.312	
1.799	15.057	14	N/A	BCE255	1.303	I	3.105	
					1.042	S	1.459	
2.339	16.623	12	N/A	BCE256	1.343	I	5.064	
					1.074	S	2.027	

WEIGHT PER FT	EST PER	FACTOR	CAVITY AREA	PART NUMBER	STRUCTURAL VALUES			1/8 SIZE DETAILS
					X-X	I	Y-Y	
2.975	20.655	12	N/A	BCE257	2.309	I	12.695	
					1.835	S	3.368	
0.186	5.178	28	N/A	BCE258	0.010	I	0.022	
					0.016	S	0.034	
0.257	7.394	29	N/A	BCE259	0.036	I	0.046	
					0.058	S	0.048	
0.460	7.609	17	N/A	BCE260	0.009	I	0.262	
					0.021	S	0.220	
0.241	7.720	32	N/A	BCE261	0.010	I	0.177	
					0.019	S	0.142	
0.248	7.969	32	N/A	BCE262	0.012	I	0.187	
					0.021	S	0.150	
0.868	18.294	21	N/A	BCE263	0.841	I	0.724	
					0.673	S	0.398	
1.060	22.297	21	N/A	BCE264	1.076	I	1.571	
					0.861	S	0.673	
0.433	11.849	27	N/A	BCE265	0.088	I	0.381	
					0.087	S	0.305	
0.872	12.492	14	N/A	BCE266	0.166	I	0.243	
					0.162	S	0.192	
1.234	16.566	13	N/A	BCE267	0.183	I	1.590	
					0.139	S	0.751	
0.121	4.134	34	N/A	BCE268	0.003	I	0.012	
					0.006	S	0.018	
0.269	5.353	20	N/A	BCE269	0.009	I	0.023	
					0.018	S	0.046	
0.240	6.894	29	N/A	BCE270	0.033	I	0.036	
					0.053	S	0.040	
0.505	13.849	27	N/A	BCE271	0.191	I	0.471	
					0.149	S	0.377	
1.837	13.008	13	N/A	BCE272	1.421	I	2.862	
					1.137	S	1.548	

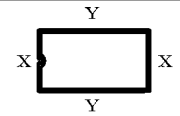
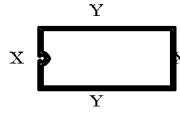
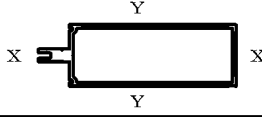
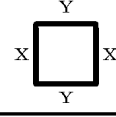
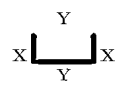
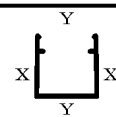
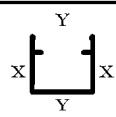
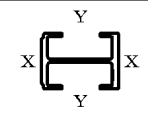
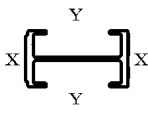
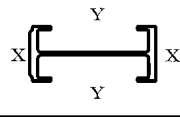
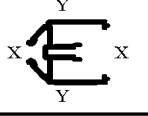
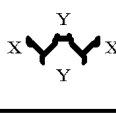
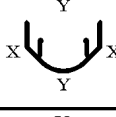
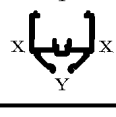
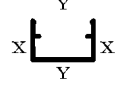
PRICING FACTORS
2 1/2" PRESSURE SYSTEM
BCE-250

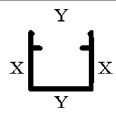
WEIGHT PER FT	EST PER	FACTOR	CAVITY AREA	PART NUMBER	STRUCTURAL VALUES			1/8 SIZE DETAILS
					X-X	Y-Y	I S	
1.669	14.330	17	N/A	BCE273	1.500	I	3.868	
					1.200	S	1.685	
2.156	16.588	15	N/A	BCE274	1.870	I	7.680	
					1.496	S	2.724	
3.988	23.093	10	N/A	BCE275	3.189	I	22.300	
					2.551	S	5.574	
0.872	9.957	22	N/A	BCE276	0.713	I	0.713	
					0.570	S	0.570	
0.344	9.427	27	N/A	BCE277	0.039	I	0.281	
					0.048	S	0.225	
0.564	15.846	28	N/A	BCE278	0.340	I	0.524	
					0.217	S	0.419	
0.582	15.500	27	N/A	BCE279	0.289	I	0.548	
					0.204	S	0.438	
2.035	18.753	9	N/A	BCE280	0.734	I	2.741	
					0.656	S	1.728	
2.413	20.403	8	N/A	BCE281	0.799	I	5.913	
					0.714	S	2.798	
2.518	22.083	9	N/A	BCE282	0.752	I	9.297	
					0.687	S	3.587	
1.462	26.387	18	N/A	BCE283	0.943	I	0.872	
					0.750	S	0.466	
0.592	10.761	18	N/A	BCE284	0.035	I	0.347	
					0.054	S	0.241	
0.524	14.461	28	N/A	BCE285	0.134	I	0.528	
					0.113	S	0.352	
0.924	19.847	21	N/A	BCE286	0.295	I	0.599	
					0.214	S	0.479	
0.451	12.349	27	N/A	BCE287	0.109	I	0.404	
					0.101	S	0.323	

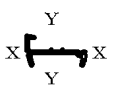
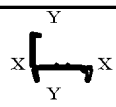
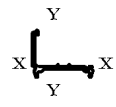
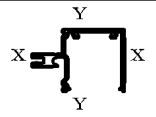
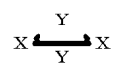
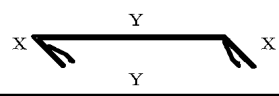
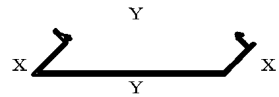
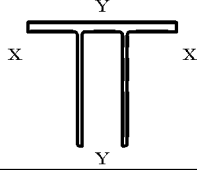
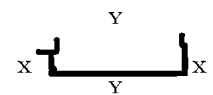
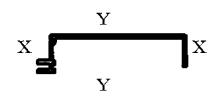
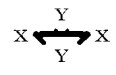
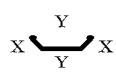
WEIGHT PER FT	EST PER	FACTOR	CAVITY AREA	PART NUMBER	STRUCTURAL VALUES			1/8 SIZE DETAILS
					X-X	I	Y-Y	
0.589	15.703	27	N/A	BCE288	0.309	I	0.558	
					0.213	S	0.446	
0.329	6.882	21	N/A	BCE289	0.007	I	0.189	
					0.015	S	0.159	
1.240	22.892	18	N/A	BCE290	0.810	I	0.543	
					0.648	S	0.336	
0.563	9.303	17	N/A	BCE294	0.036	I	0.360	
					0.052	S	0.256	
0.646	10.677	17	N/A	BCE295	0.134	I	0.418	
					0.110	S	0.273	
0.604	9.917	16	N/A	BCE296	0.114	I	0.359	
					0.087	S	0.226	
1.536	22.508	15	N/A	BCE298	0.644	I	2.045	
					0.430	S	1.055	
0.229	5.893	26	N/A	BCE299	0.001	I	0.107	
					0.003	S	0.095	
1.492	27.107	18	N/A	BCE2537	0.160	I	10.476	
					0.166	S	2.174	
1.565	25.960	17	N/A	BCE2538	0.393	I	11.429	
					0.283	S	2.373	
4.794	30.915	6	N/A	BCE2550	9.174	I	8.210	
					2.458	S	2.737	
1.078	18.762	17	N/A	BCE2552	0.176	I	3.883	
					0.138	S	1.238	
1.184	19.450	16	N/A	BCE2553	0.263	I	4.441	
					0.247	S	1.326	
0.338	6.763	20	N/A	BCE2556	0.003	I	0.129	
					0.009	S	0.116	
0.168	6.039	36	N/A	BCE2557	0.004	I	0.089	
					0.012	S	0.071	

PRICING FACTORS
2 1/2" PRESSURE SYSTEM
BCE-250

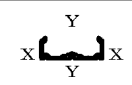
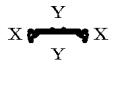
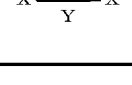
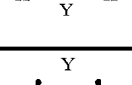
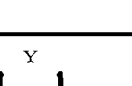
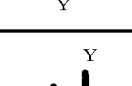
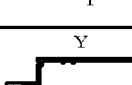
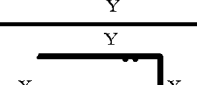
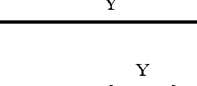
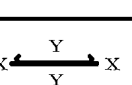
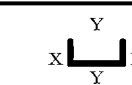
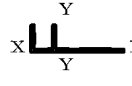
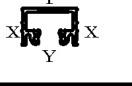
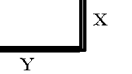
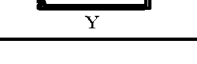
WEIGHT PER FT	EST PER	FACTOR	CAVITY AREA	PART NUMBER	STRUCTURAL VALUES			1/8 SIZE DETAILS
					X-X	Y-Y		
0.436	9.872	23	N/A	BCE2558	0.022 I 0.277 0.033 S 0.221			
0.397	6.986	18	N/A	BCE2560	0.003 I 0.207 0.009 S 0.174			
0.264	8.415	32	N/A	BCE2561	0.010 I 0.200 0.019 S 0.160			
0.271	8.664	32	N/A	BCE2562	0.012 I 0.208 0.022 S 0.166			
0.220	6.975	32	N/A	BCE2563	0.004 I 0.150 0.010 S 0.120			
0.234	7.481	32	N/A	BCE2564	0.007 I 0.168 0.015 S 0.134			
0.449	11.197	25	N/A	BCE2565	0.121 I 0.364 0.117 S 0.291			
1.308	17.570	13	N/A	BCE2567	0.189 I 2.149 0.141 S 0.884			
2.002	34.355	17	N/A	BCE2575	1.686 I 6.835 1.349 S 1.743			
1.267	25.387	20	N/A	BCE2576	1.345 I 2.731 1.076 S 0.930			
0.304	7.012	23	N/A	BCE492	0.001 I 0.201 0.004 S 0.141			
0.370	8.473	23	N/A	BCE475	0.001 I 0.356 0.003 S 0.204			
0.600	8.229	14	N/A	A1253	0.045 I 0.366 0.063 S 0.325			
0.852	11.579	14	N/A	BCE212	0.067 I 0.896 0.079 S 0.382			
1.224	15.282	12	N/A	BCE2570	0.257 I 0.676 0.317 S 0.601			
2.057	15.008	14	N/A	BCE2573	1.714 I 5.065 1.371 S 2.231			

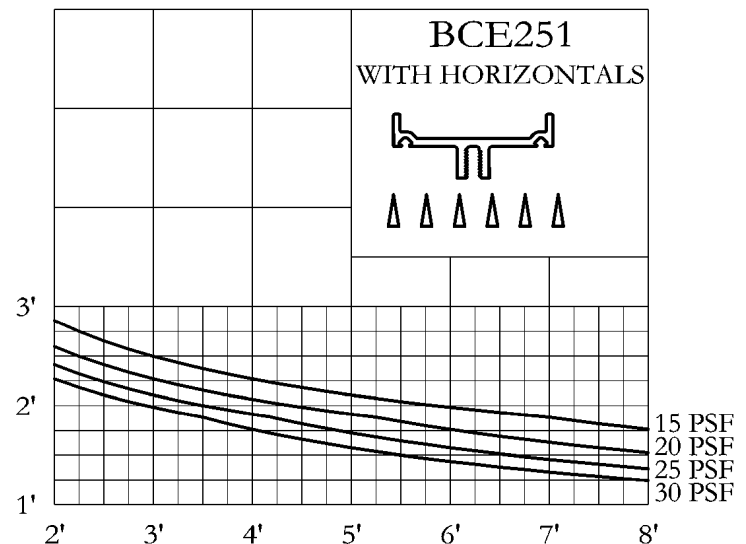
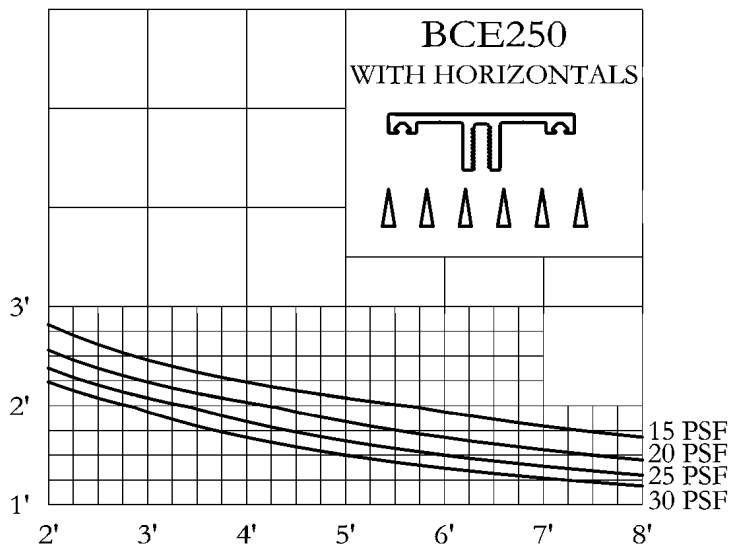
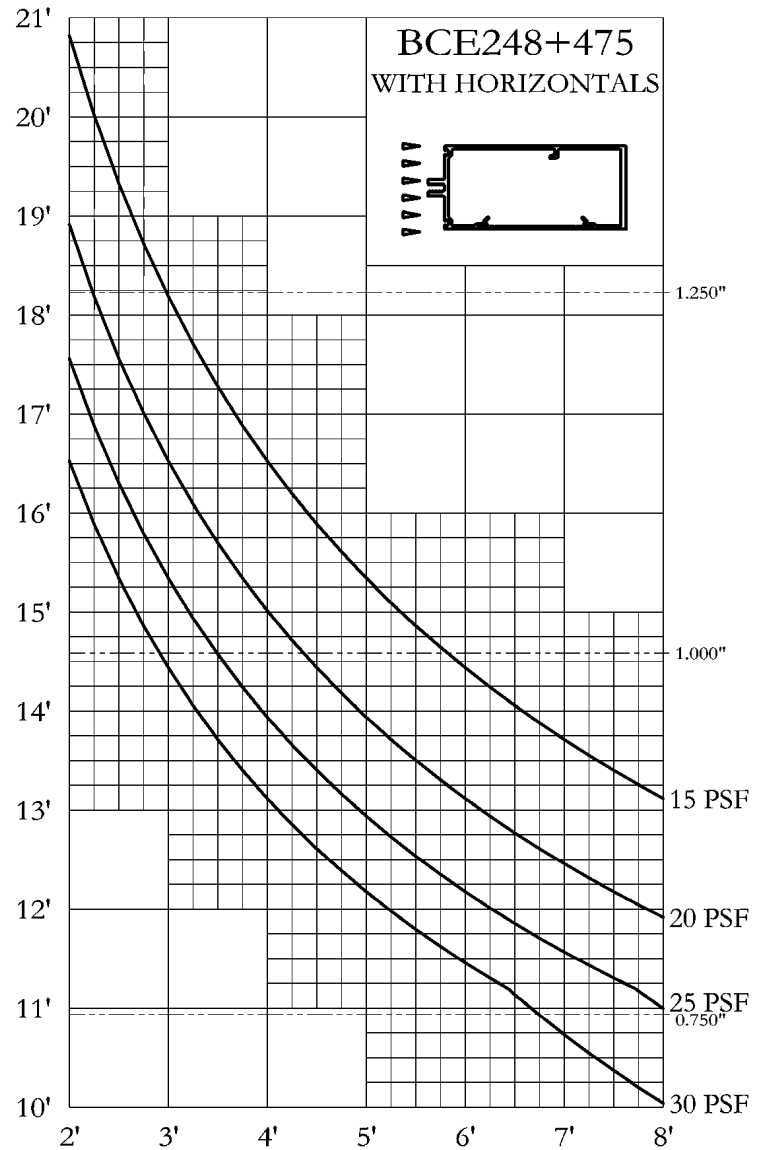
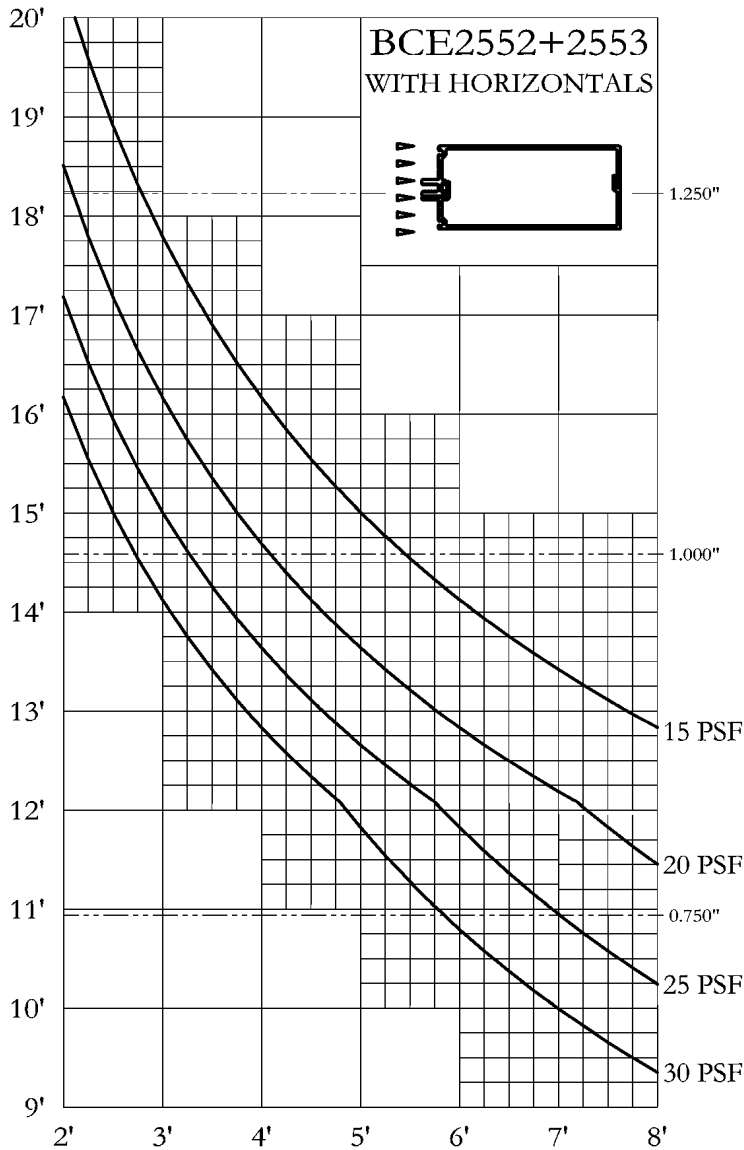

#1 THESE WINDLOAD CHARTS ARE BASED UPON THE LESSER OF DEFLECTION RATIO (L/175) OR STRESS (12667)

#2 THESE STRUCTURAL CURVES ARE ESTIMATES AND ARE PRESENTED TO THE BEST KNOWLEDGE OF THE WILLIAM L BONNELL CO. IT IS, HOWEVER, THE RESPONSIBILITY OF THE CUSTOMER TO BE SATISFIED THAT THE CURVES ARE CORRECT. THE WILLIAM L BONNELL CO. MAY NOT BE HELD RESPONSIBLE IN ANY WAY FOR THE FAILURE OF PERFORMANCE RESULTING FROM THE USE OF THESE CURVES.

WINDLOAD CHARTS
2 1/2" PRESSURE SYSTEM
BCE-250

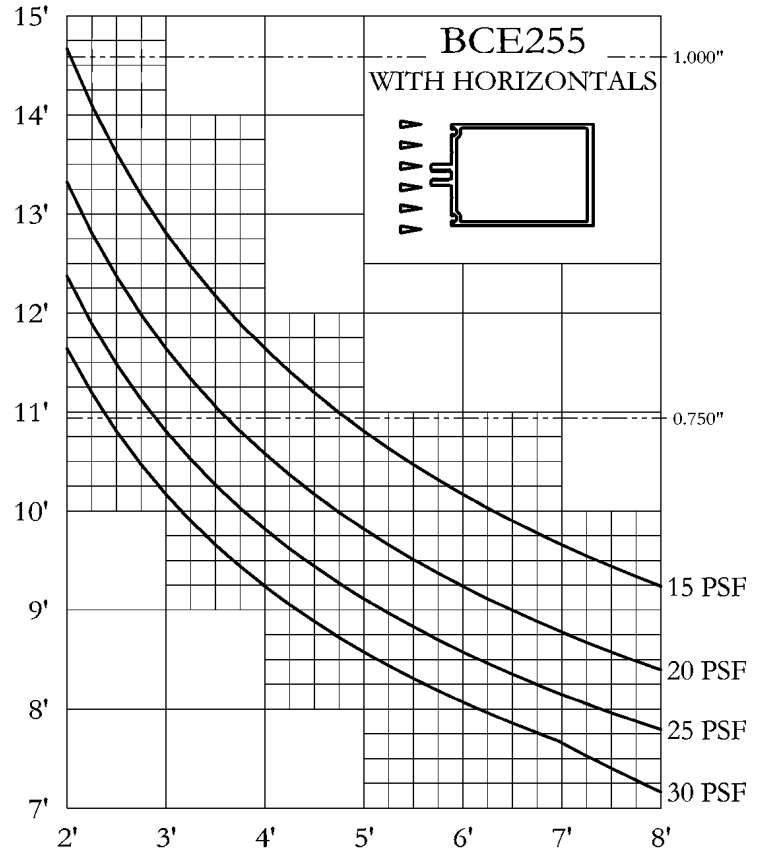
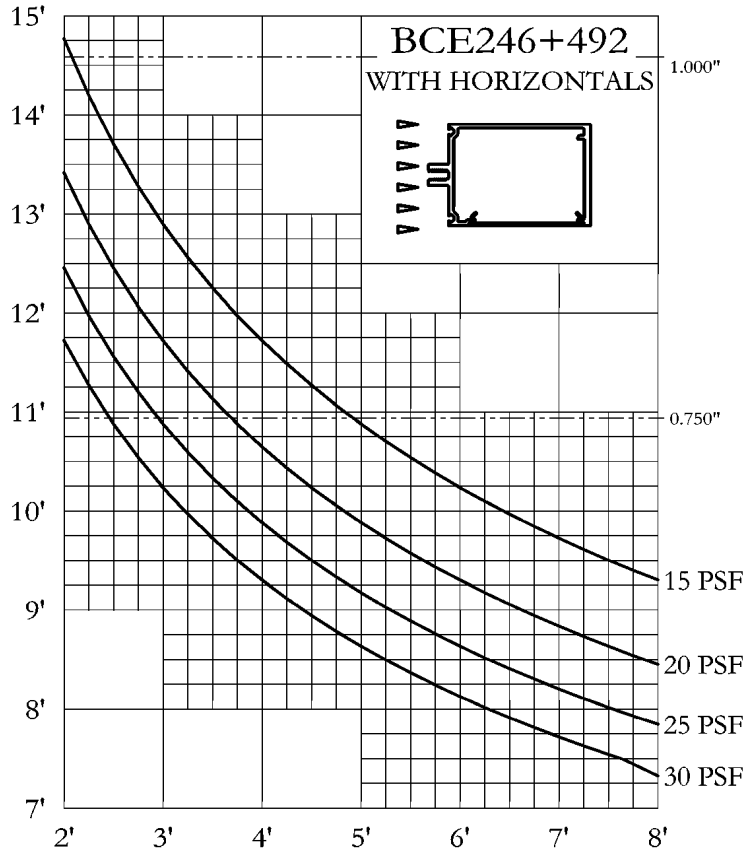

#1 THESE WINDLOAD CHARTS ARE BASED UPON THE LESSER OF DEFLECTION RATIO ($L/175$) OR STRESS (12667)

#2 THESE STRUCTURAL CURVES ARE ESTIMATES AND ARE PRESENTED TO THE BEST KNOWLEDGE OF THE WILLIAM L BONNELL CO. IT IS, HOWEVER, THE RESPONSIBILITY OF THE CUSTOMER TO BE SATISFIED THAT THE CURVES ARE CORRECT. THE WILLIAM L BONNELL CO. MAY NOT BE HELD RESPONSIBLE IN ANY WAY FOR THE FAILURE OF PERFORMANCE RESULTING FROM THE USE OF THESE CURVES.

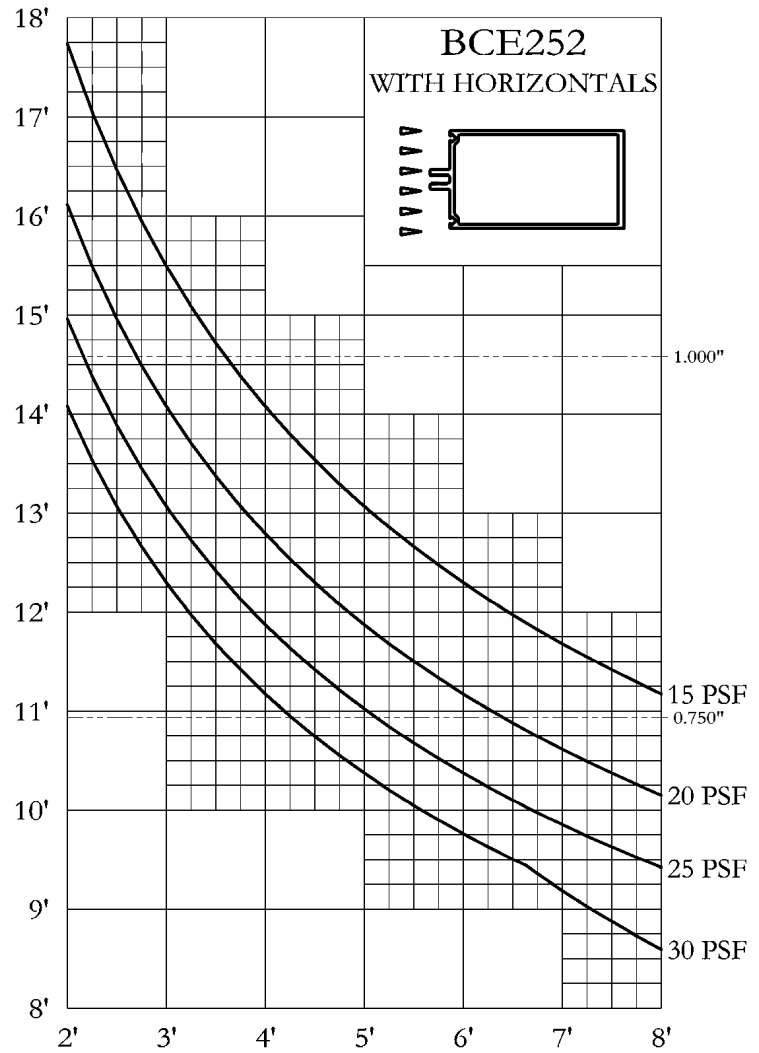
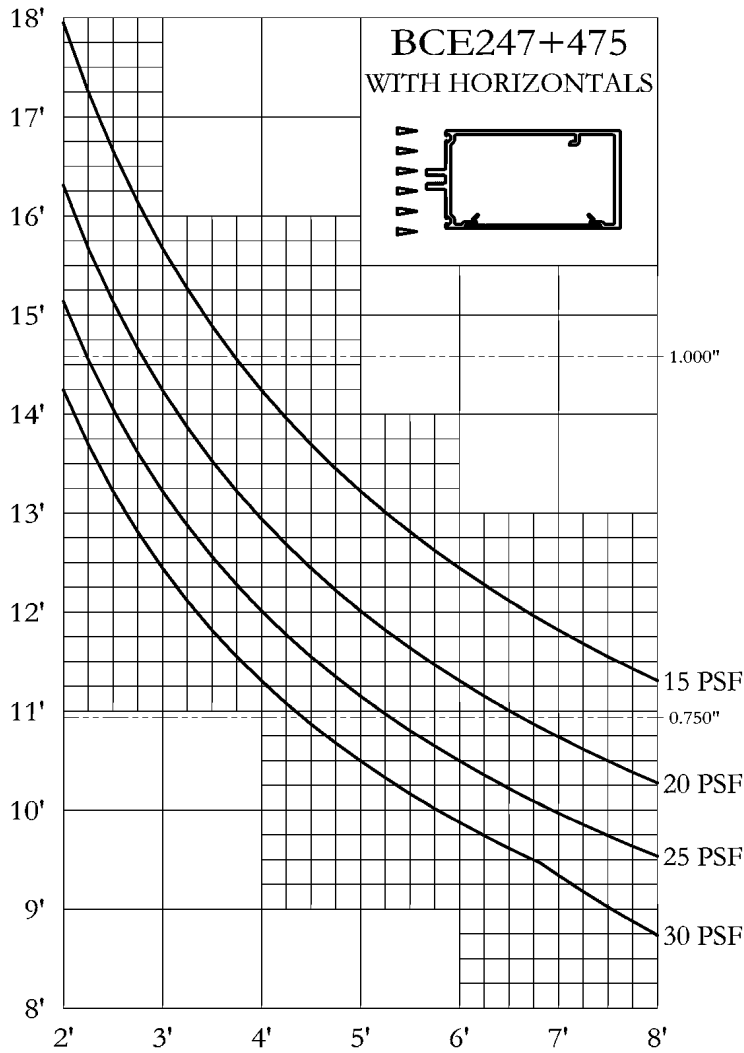

#1 THESE WINDLOAD CHARTS ARE BASED UPON THE LESSER OF DEFLECTION RATIO ($L/175$) OR STRESS (12667)

#2 THESE STRUCTURAL CURVES ARE ESTIMATES AND ARE PRESENTED TO THE BEST KNOWLEDGE OF THE WILLIAM L BONNELL CO. IT IS, HOWEVER, THE RESPONSIBILITY OF THE CUSTOMER TO BE SATISFIED THAT THE CURVES ARE CORRECT. THE WILLIAM L BONNELL CO. MAY NOT BE HELD RESPONSIBLE IN ANY WAY FOR THE FAILURE OF PERFORMANCE RESULTING FROM THE USE OF THESE CURVES.

WINDLOAD CHARTS
2 1/2" PRESSURE SYSTEM
BCE-250

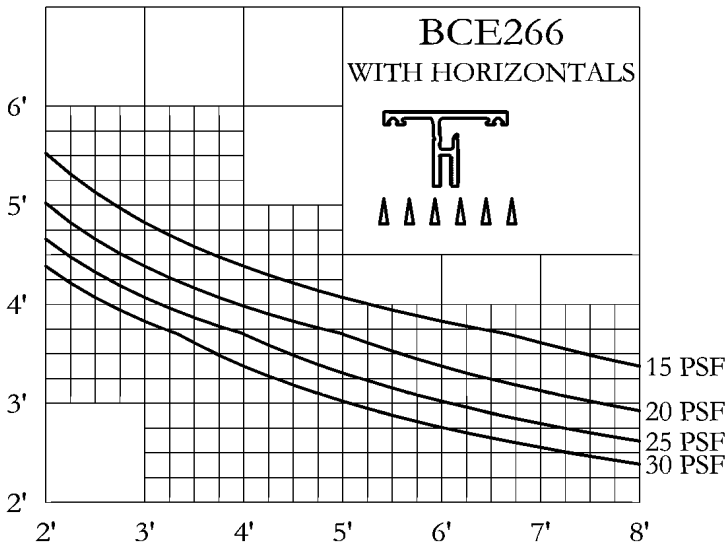
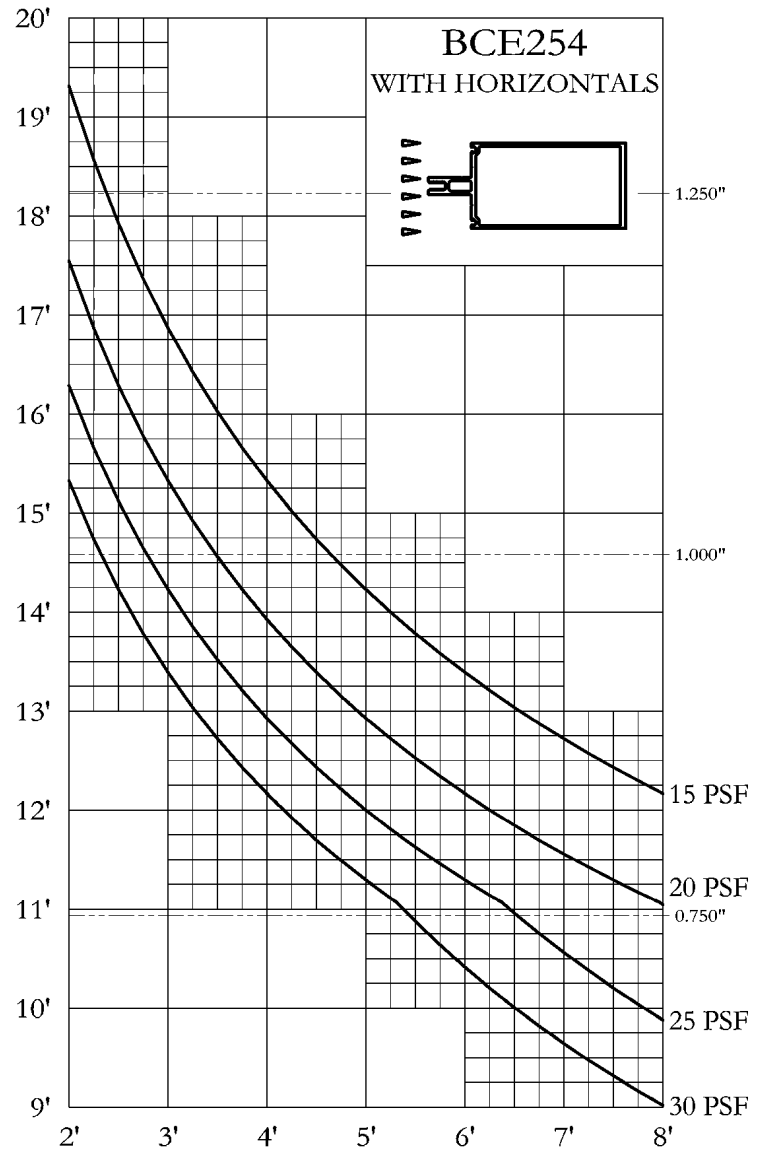
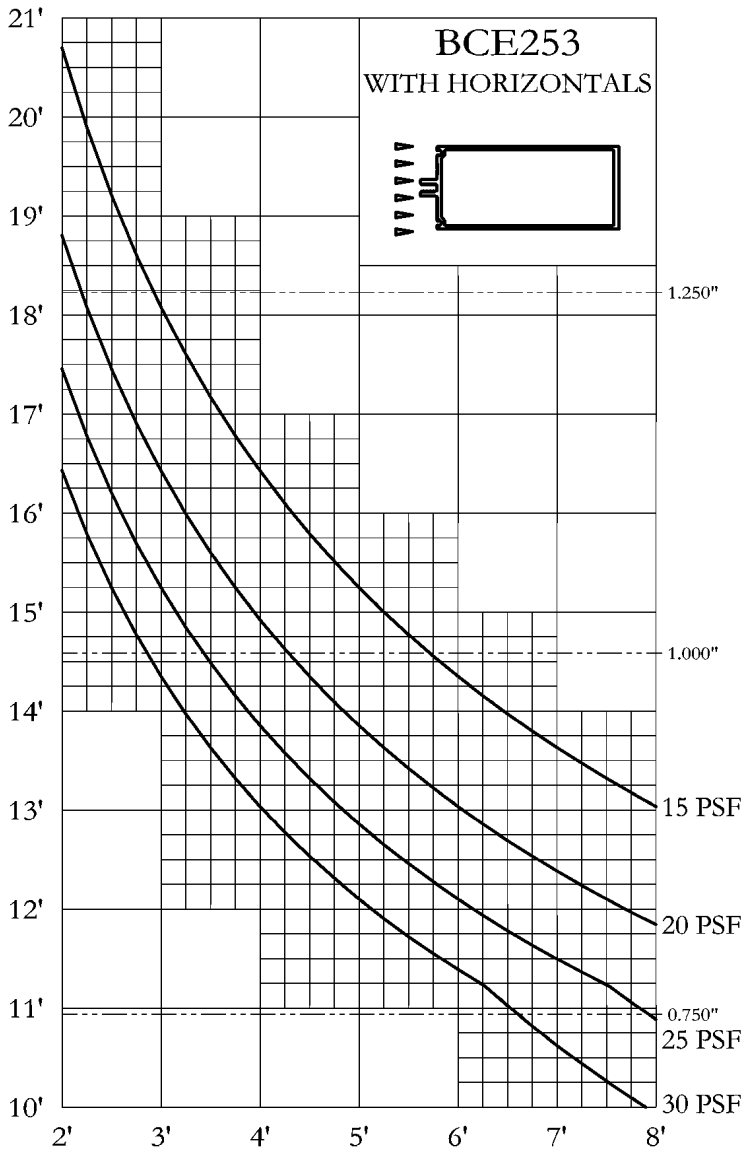

#1 THESE WINDLOAD CHARTS ARE BASED UPON THE LESSER OF DEFLECTION RATIO (L/175) OR STRESS (12667)

#2 THESE STRUCTURAL CURVES ARE ESTIMATES AND ARE PRESENTED TO THE BEST KNOWLEDGE OF THE WILLIAM L BONNELL CO. IT IS, HOWEVER, THE RESPONSIBILITY OF THE CUSTOMER TO BE SATISFIED THAT THE CURVES ARE CORRECT. THE WILLIAM L BONNELL CO. MAY NOT BE HELD RESPONSIBLE IN ANY WAY FOR THE FAILURE OF PERFORMANCE RESULTING FROM THE USE OF THESE CURVES.

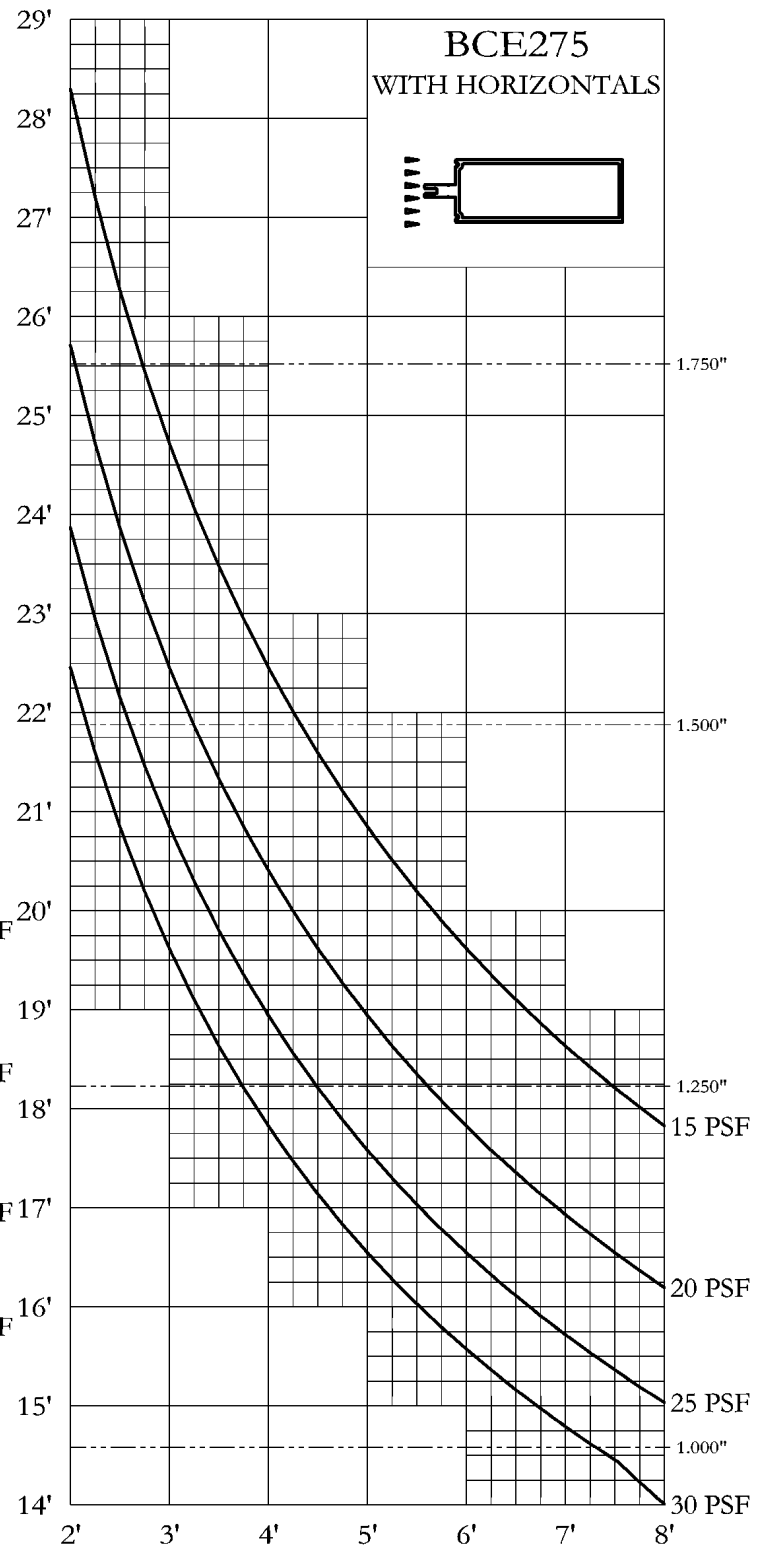
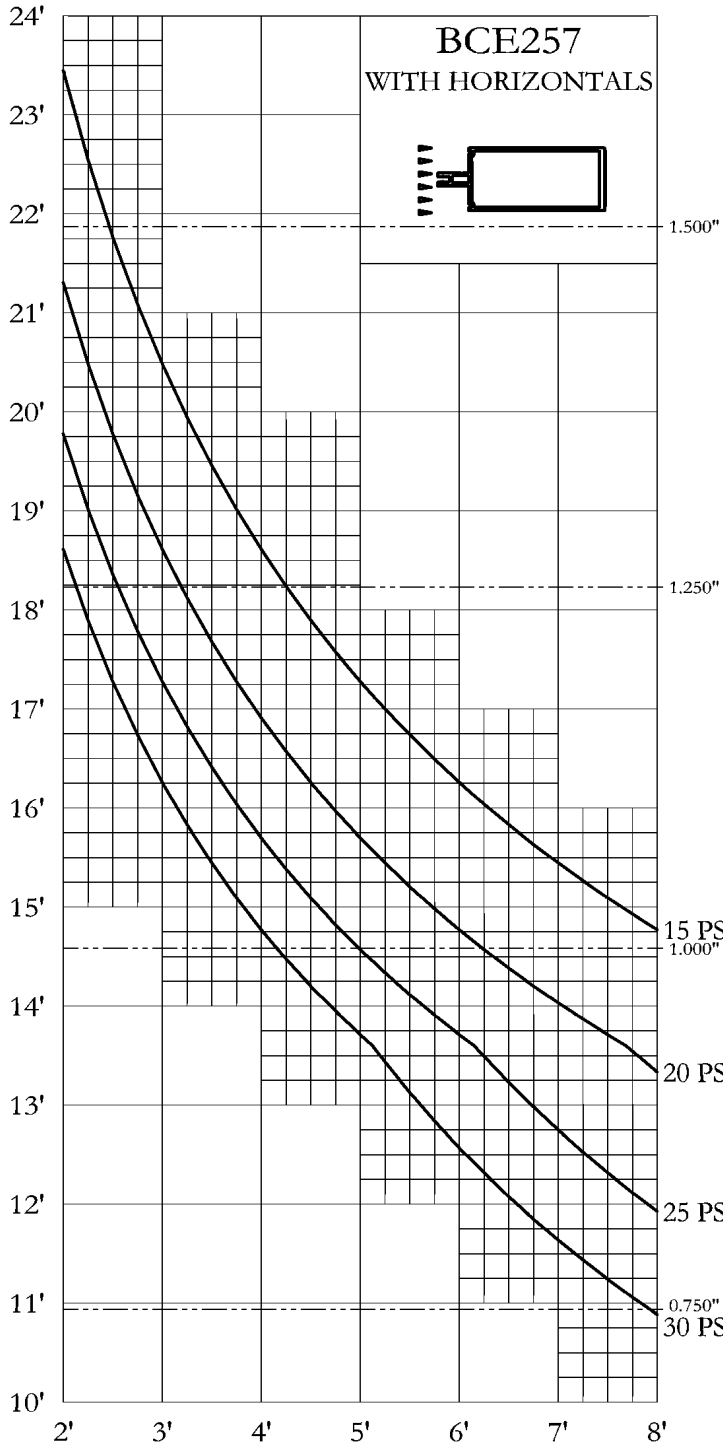

#1 THESE WINDLOAD CHARTS ARE BASED UPON THE LESSER OF DEFLECTION RATIO (L/175) OR STRESS (12667)

#2 THESE STRUCTURAL CURVES ARE ESTIMATES AND ARE PRESENTED TO THE BEST KNOWLEDGE OF THE WILLIAM L BONNELL CO. IT IS, HOWEVER, THE RESPONSIBILITY OF THE CUSTOMER TO BE SATISFIED THAT THE CURVES ARE CORRECT. THE WILLIAM L BONNELL CO. MAY NOT BE HELD RESPONSIBLE IN ANY WAY FOR THE FAILURE OF PERFORMANCE RESULTING FROM THE USE OF THESE CURVES.

WINDLOAD CHARTS
2 1/2" PRESSURE SYSTEM
BCE-250

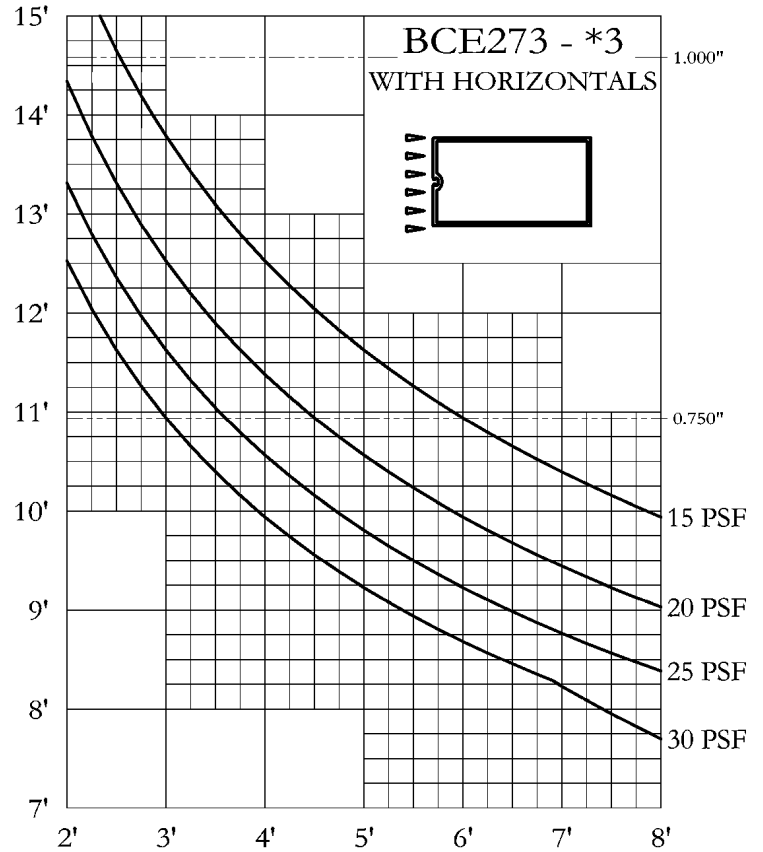
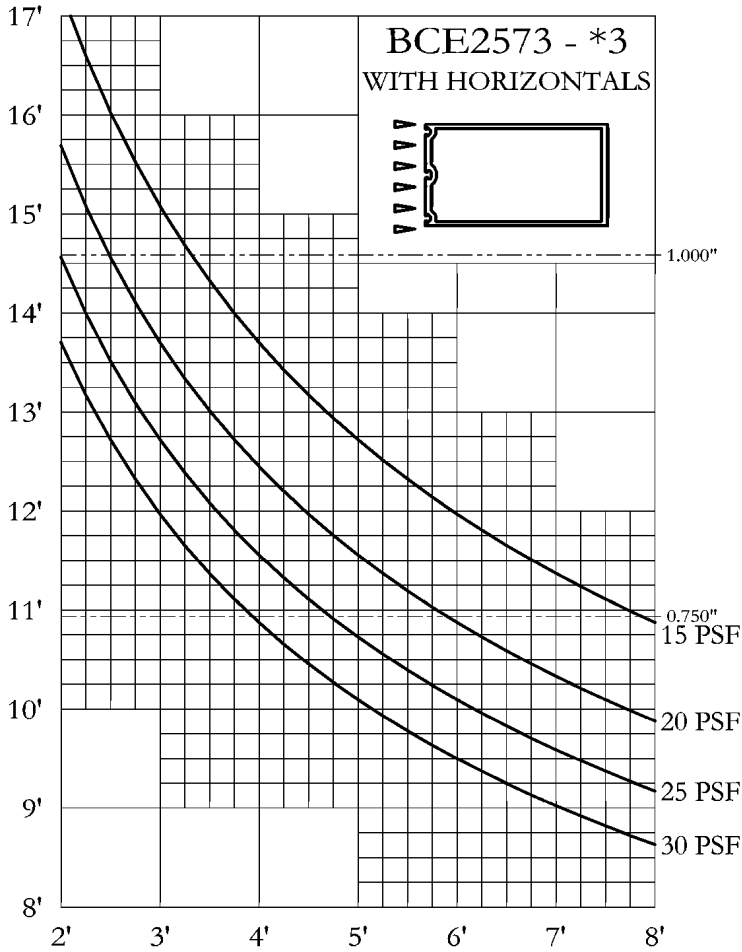

SPECIAL NOTE *3: THESE WIND LOAD VALUES ILLUSTRATE THE ABILITY OF THE ALUMINUM TO RESIST A WIND LOAD. CONTACT YOUR SILICONE SUPPLIER TO ASSURE THE ABILITY OF THE SILICONE TO WITHSTAND THE LOAD.

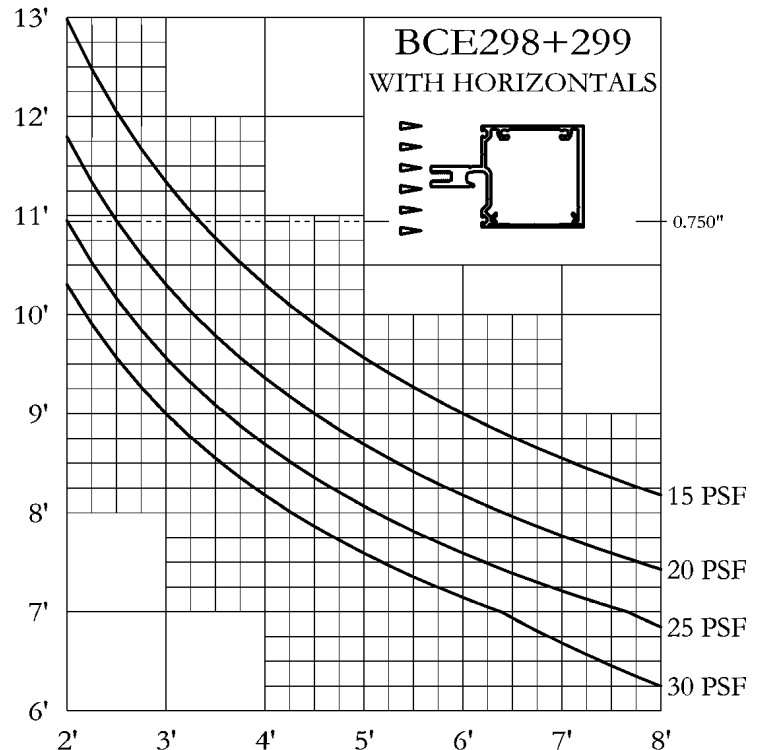
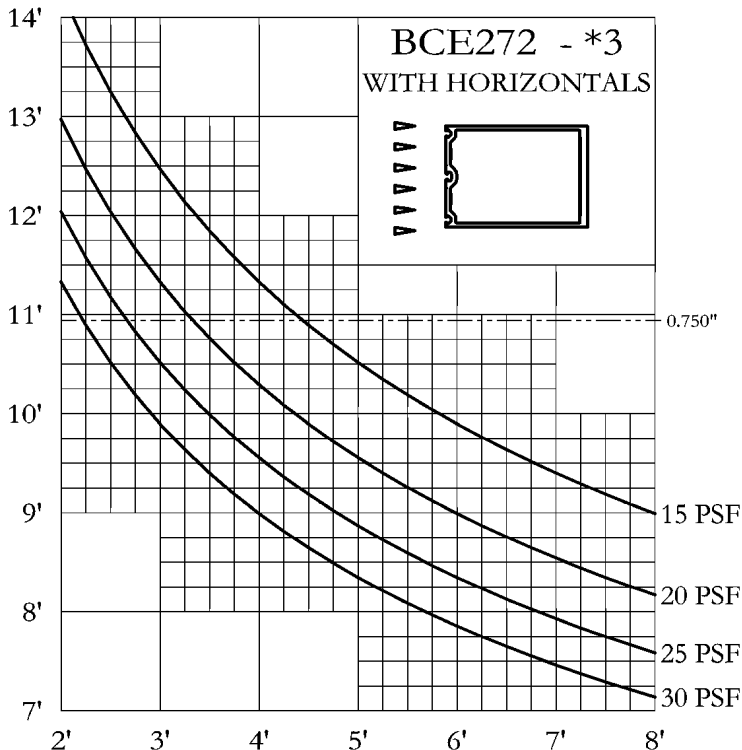

#1 THESE WINDLOAD CHARTS ARE BASED UPON THE LESSER OF DEFLECTION RATIO (L/175) OR STRESS (12667)

#2 THESE STRUCTURAL CURVES ARE ESTIMATES AND ARE PRESENTED TO THE BEST KNOWLEDGE OF THE WILLIAM L BONNELL CO. IT IS, HOWEVER, THE RESPONSIBILITY OF THE CUSTOMER TO BE SATISFIED THAT THE CURVES ARE CORRECT. THE WILLIAM L BONNELL CO. MAY NOT BE HELD RESPONSIBLE IN ANY WAY FOR THE FAILURE OF PERFORMANCE RESULTING FROM THE USE OF THESE CURVES.

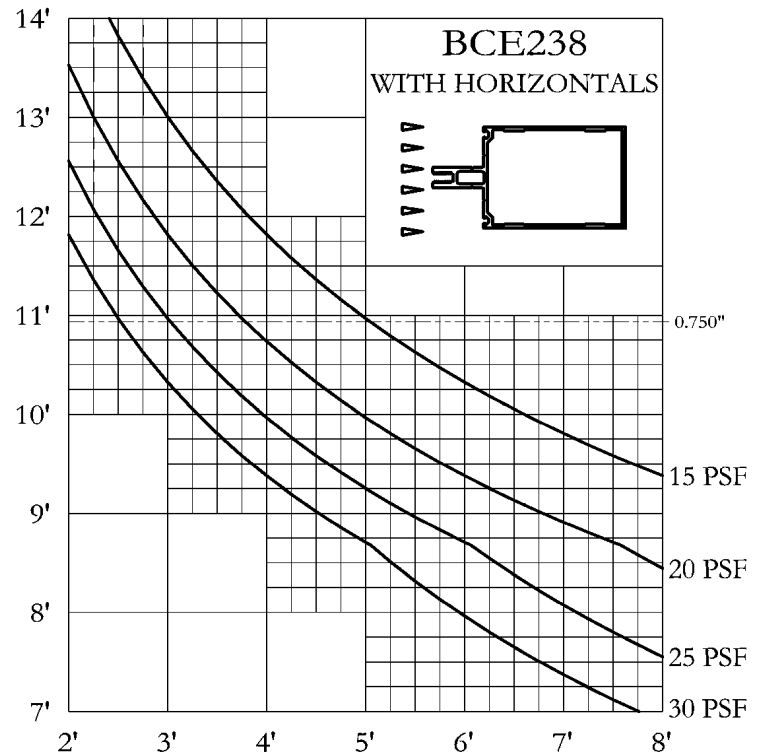
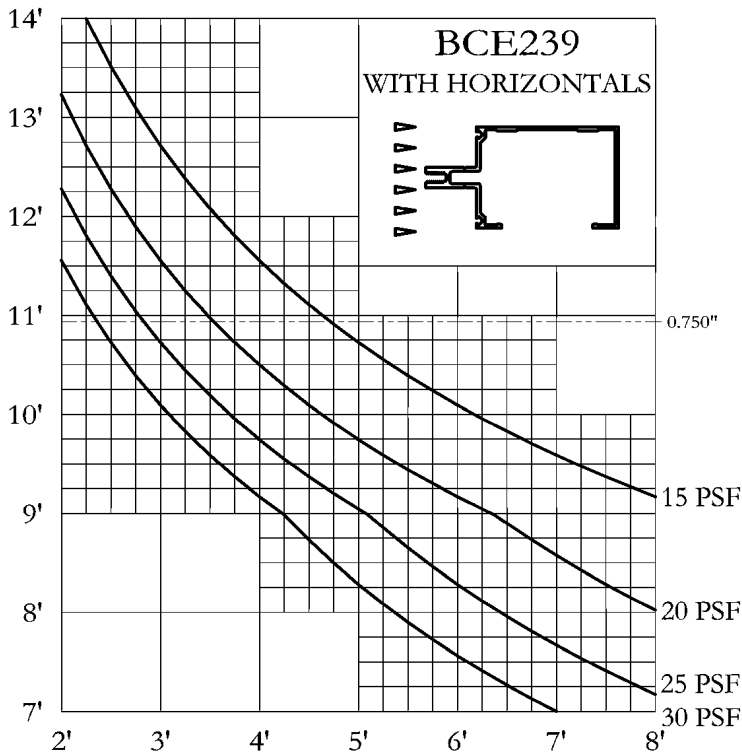
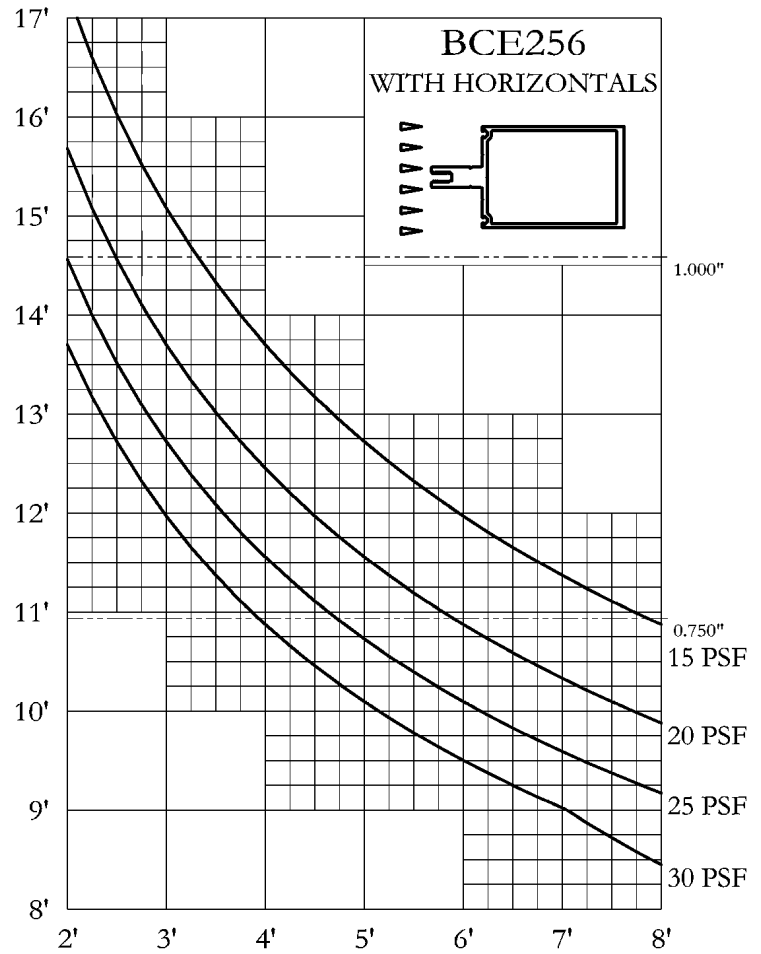
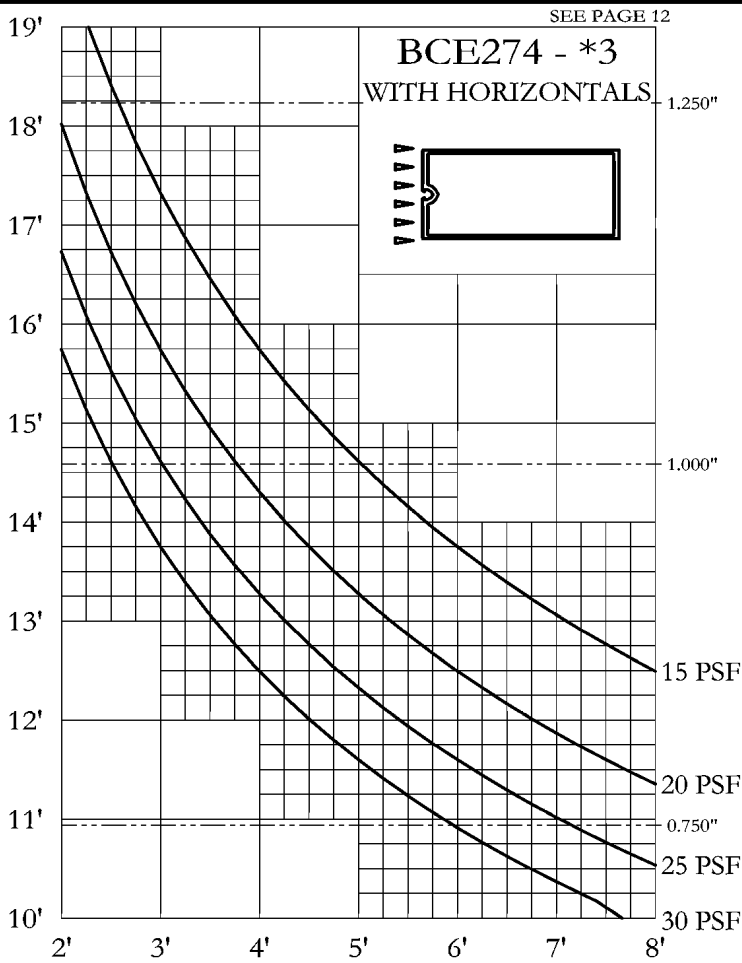

#1 THESE WINDLOAD CHARTS ARE BASED UPON THE LESSER OF DEFLECTION RATIO (L/175) OR STRESS (12667)

#2 THESE STRUCTURAL CURVES ARE ESTIMATES AND ARE PRESENTED TO THE BEST KNOWLEDGE OF THE WILLIAM L BONNELL CO. IT IS, HOWEVER, THE RESPONSIBILITY OF THE CUSTOMER TO BE SATISFIED THAT THE CURVES ARE CORRECT. THE WILLIAM L BONNELL CO. MAY NOT BE HELD RESPONSIBLE IN ANY WAY FOR THE FAILURE OF PERFORMANCE RESULTING FROM THE USE OF THESE CURVES.

GASKET INFORMATION
2 1/2" PRESSURE SYSTEM
BCE-250 SERIES



FASTENERS

1. SHEAR BLOCK ATTACHMENTS ARE INTENDED TO BE SECURED WITH #10 SCREWS
2. PRESSURE PLATE ATTACHMENTS ARE DESIGNED TO BE SECURED WITH 1/4"-20 MACHINE SCREWS, 9" ON CENTER.
SCREWS OF MOST ASSEMBLYS ACCEPT 1/4"-20 x 3/4" LONG. CHECK YOUR COMBINATION TO CONFIRM YOUR REQUIREMENTS.
*NOTE REGARDING CORNER EXTENSIONS BCE-283, -286, & -290, SCREW LENGTHS VARY DEPENDING ON USAGE, CHECK YOUR APPLICATION FOR REQUIRED LENGTH AND THREAD TYPE.
3. ANCHOR BOLTS SHOULD BE SIZED ACCORDING TO LOAD REQUIREMENTS.

GASKETS

UNIVERSAL RUBBER CO. 800-782-2375	#2272	SPONGE GLAZING GASKET EXTERIOR
	#2337	SPONGE GLAZING GASKET EXTERIOR
	#2148	SPONGE GLAZING GASKET EXTERIOR
	#2338	HARD GLAZING GASKET INTERIOR
REED RUBBER PRODUCTS 800-325-9698	#B-115	SPONGE GASKET INTERIOR
	#B-116	HARD GASKET EXTERIOR
	#B-140	SPONGE GLAZING GASKET INTERIOR AND EXTERIOR
TREMCO 800-321-6357	#TR-647E	EXTERIOR GLAZING GASKET
	#TR-646N	INTERIOR GLAZING GASKET

THERMAL ISOLATOR

REBCO INC. 973-684-0200	#42-802	PRESSURE PLATE RIGID VINYL
LOXCREEN COMPANY 912-842-2439	#V-5374	PRESSURE PLATE RIGID VINYL

DOOR PILE

SCHLEGEL CORP. 800-828-6237	AS SELECTED	USED WITH BCE-5
AMESBURY GROUP INC. 704-878-6892	AS SELECTED	USED WITH BCE-5

END DAMS FOR HORIZONTALS

WHEN THIS SYSTEM IS USED IN HIGH APPLICATIONS, END DAMS ARE BENEFICIAL TO FORCE INFILTRATED MOISTURE OUT THRU WEEP HOLES IN THE HORIZONTAL PRESSURE PLATES.

A SECOND POINT OF CONCERN INVOLVES CLOSING THE ENDS OF THE GLASS SUPPORT TONGUE (SUCH AS ON BCE-239 & BCE-2575) THAT CREATES AN OPENING FROM THE GLASS POCKET TO THE INTERIOR OF THE HORIZONTAL TUBE CAVITY TO PREVENT INFILTRATED MOISTURE MIGRATING FROM THE GLASS POCKET INTO THE CAVITY.

CLOSED CELL SPONGE IS ORDERED BY SPECIFYING DIMENSIONS AND CAN BE ORDERED WITH OR WITHOUT ADHESIVE.

SEALING AROUND PLUGS TO CLOSE VOIDS MAY BE REQUIRED.

1.500 X 1.125 X .500 THK.	FOR 1" GLASS
.750 X 1.125 X .500 THK.	FOR 1/4" GLASS

SECON RUBBER AND PLASTICS INC. 618-282-7700	MAT'L : NBR/PVC BLEND
--	-----------------------

FULL SIZE DETAILS

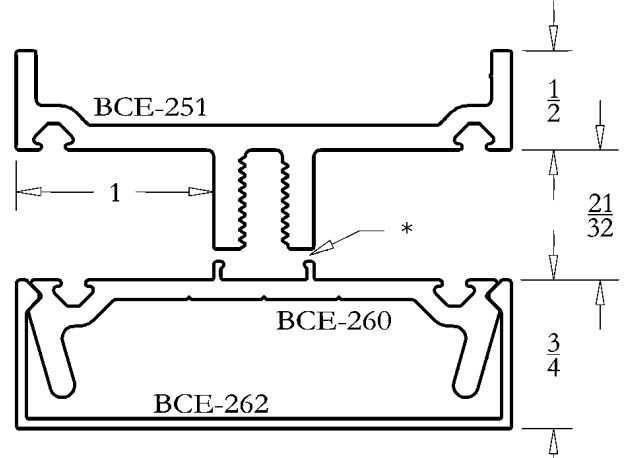
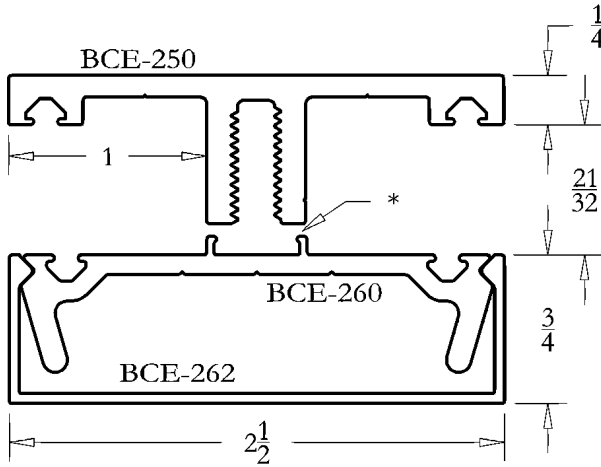

* RIGID VINYL SEPARATOR
SPECIFY SEPERATELY

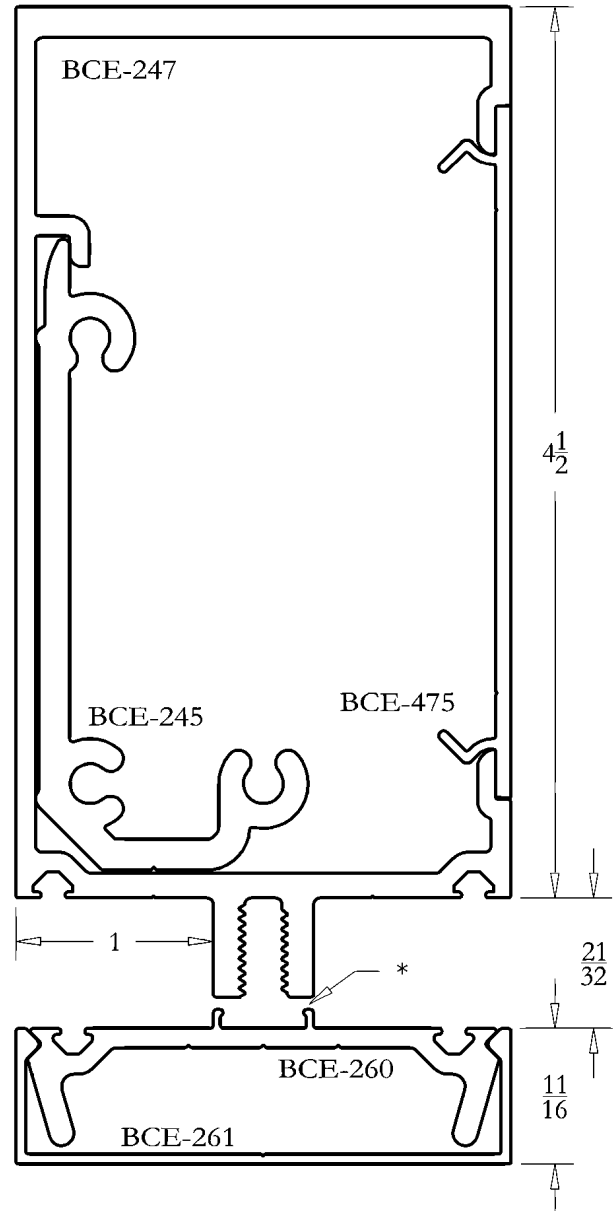
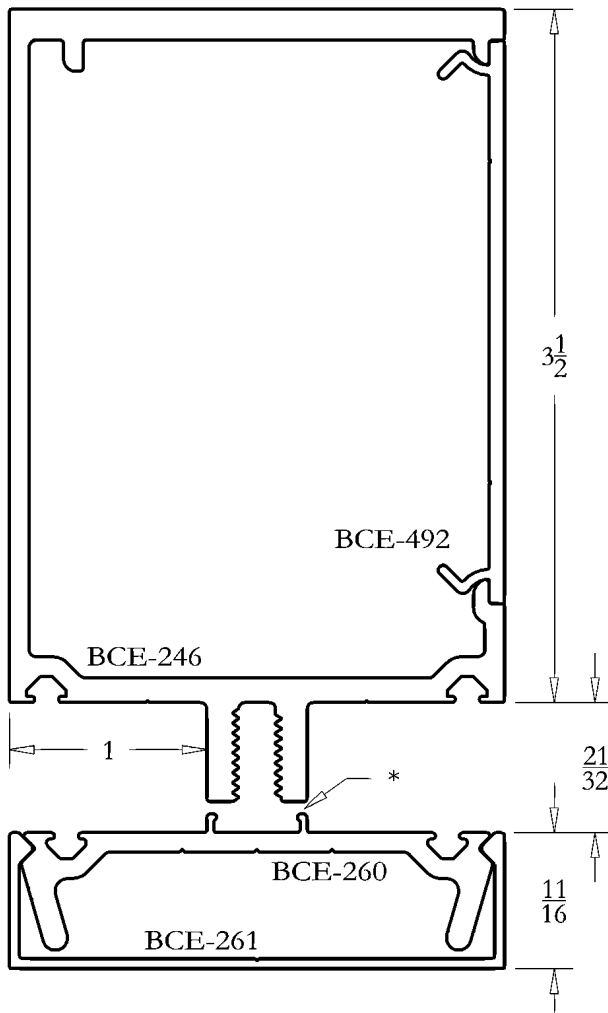

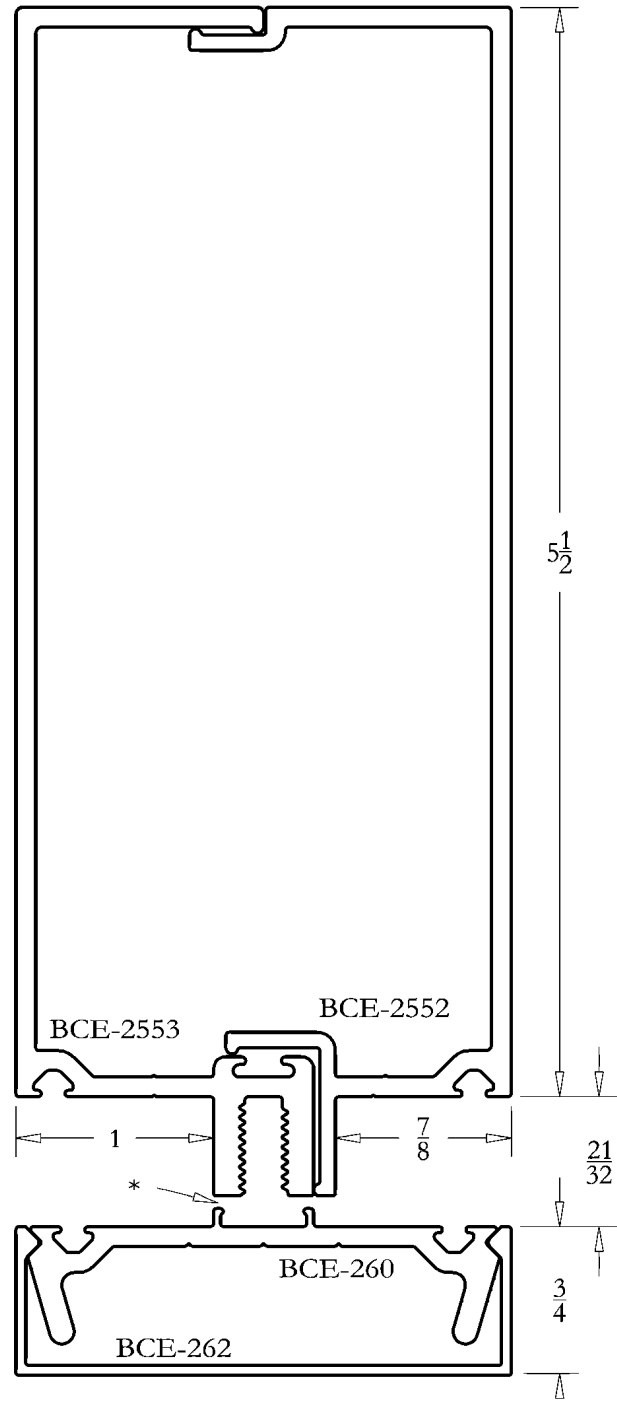
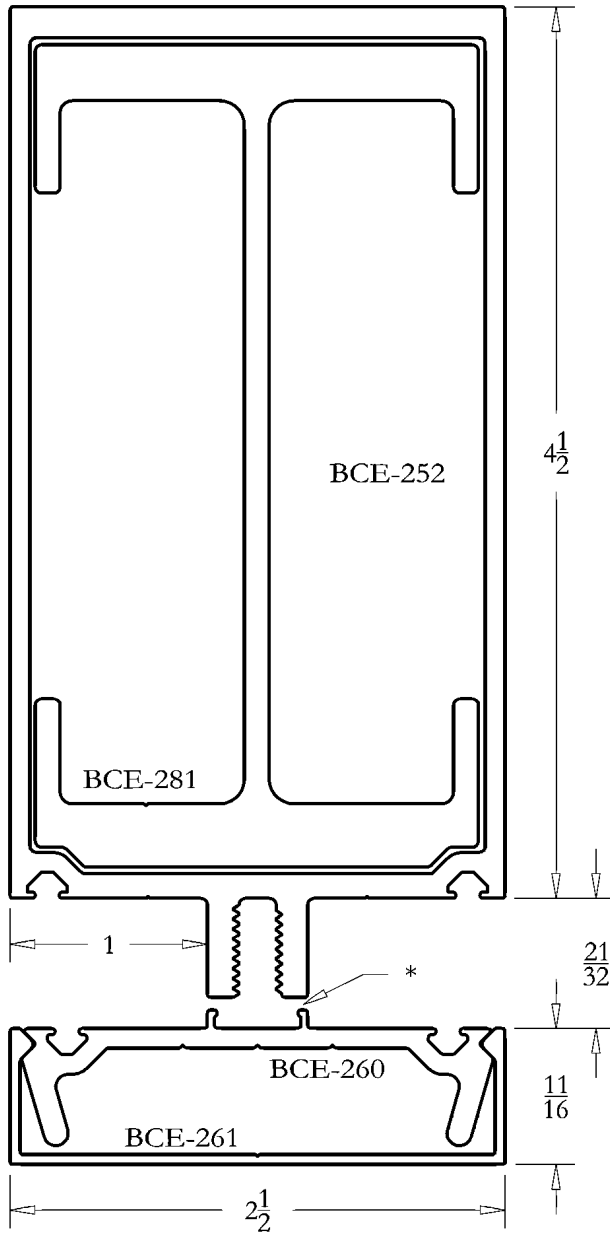

* RIGID VINYL SEPARATOR
SPECIFY SEPERATELY

FULL SIZE DETAILS

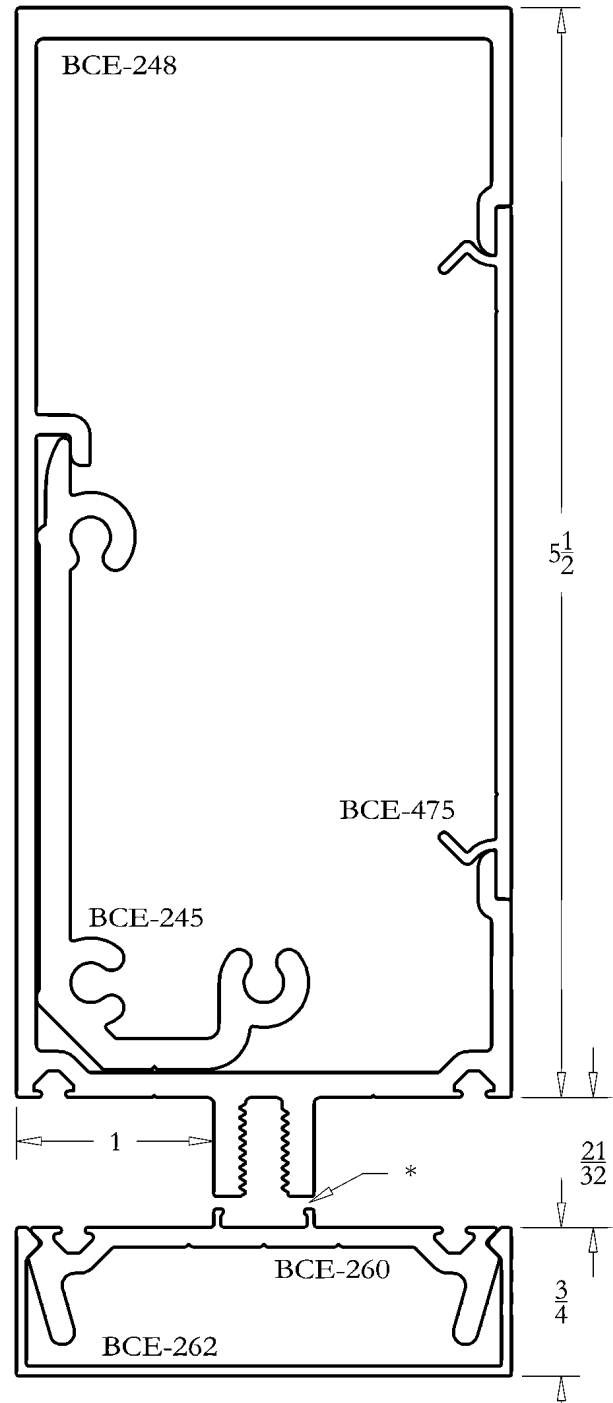
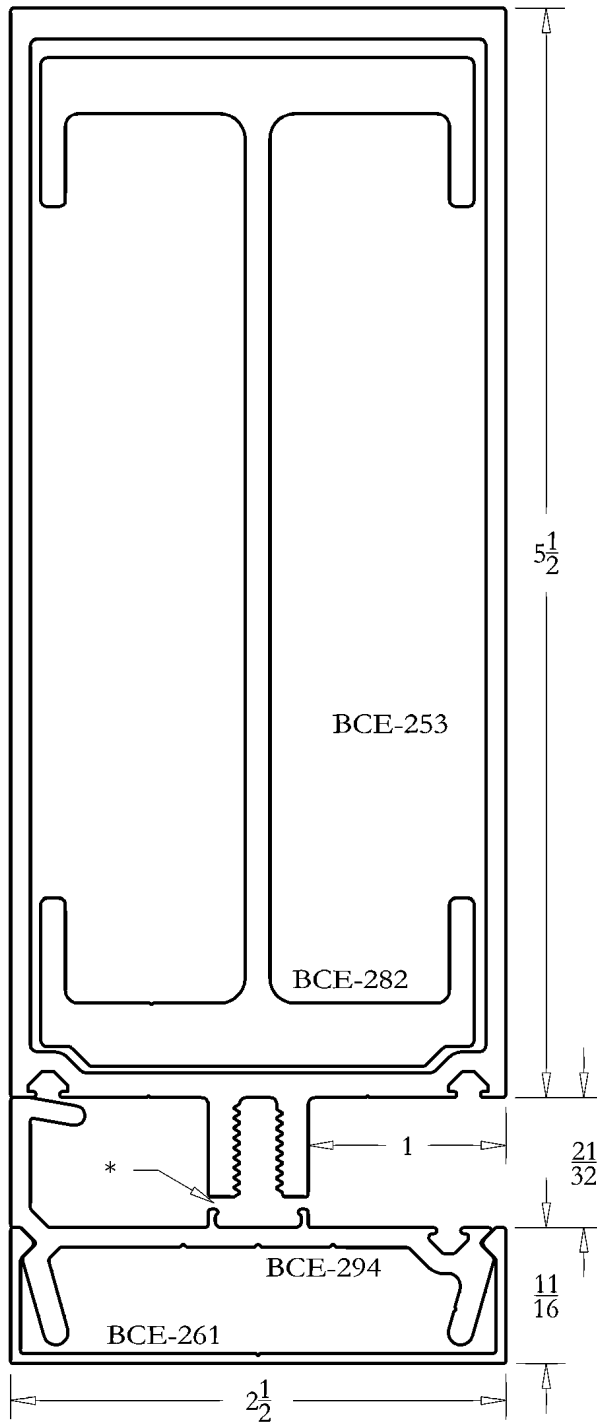

* RIGID VINYL SEPARATOR
SPECIFY SEPERATELY

DETAIL SHEET
2 1/2" PRESSURE SYSTEM
BCE-250

FULL SIZE DETAILS

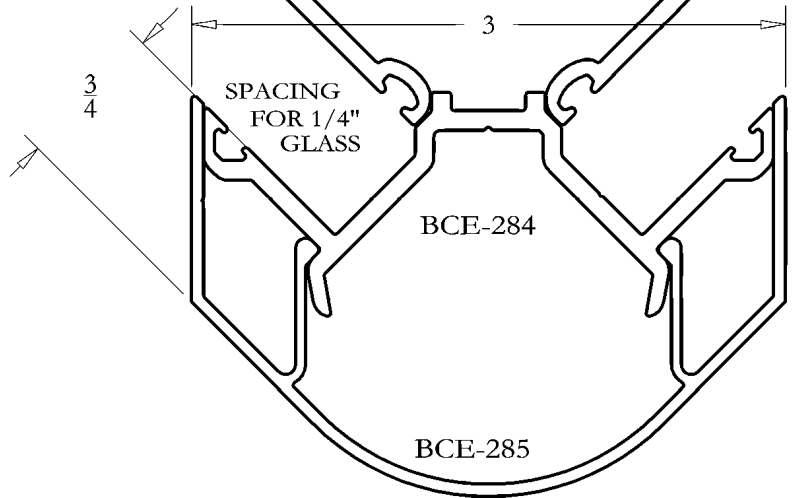
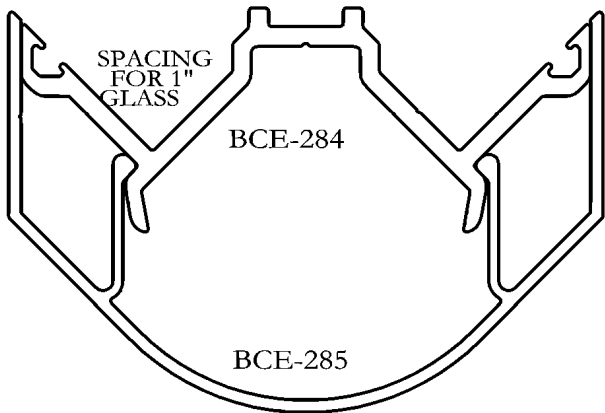
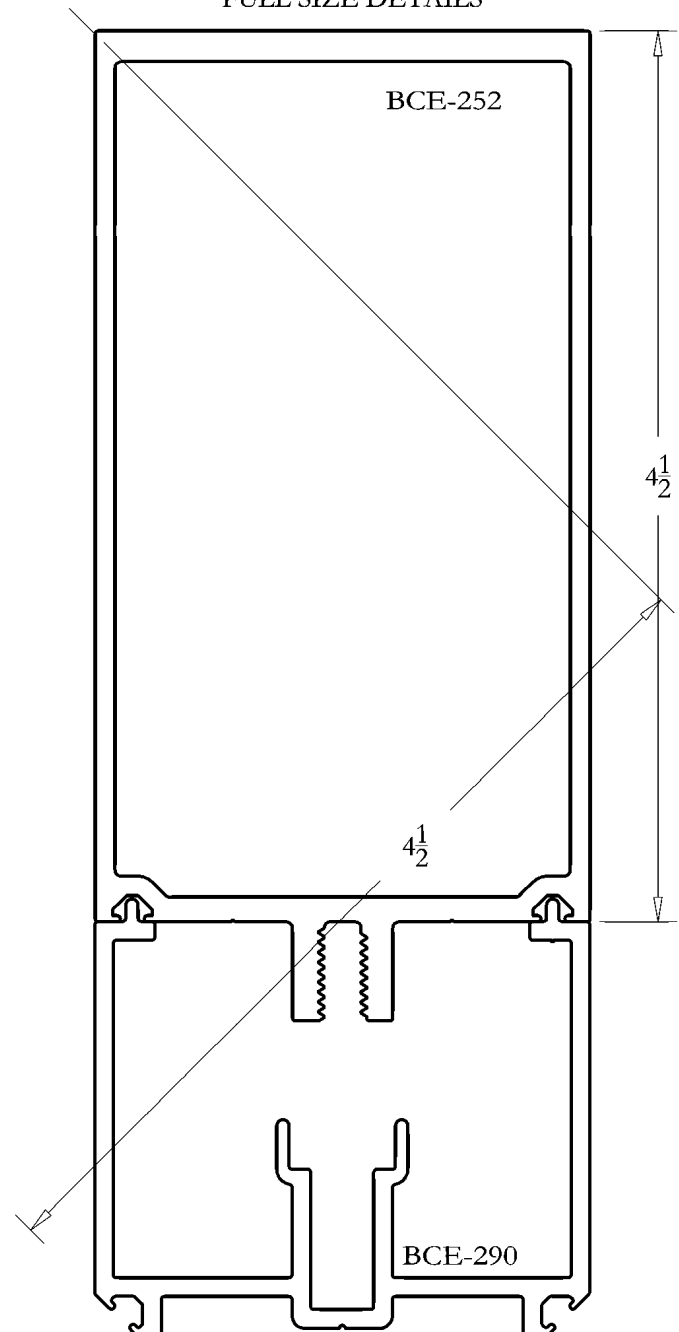
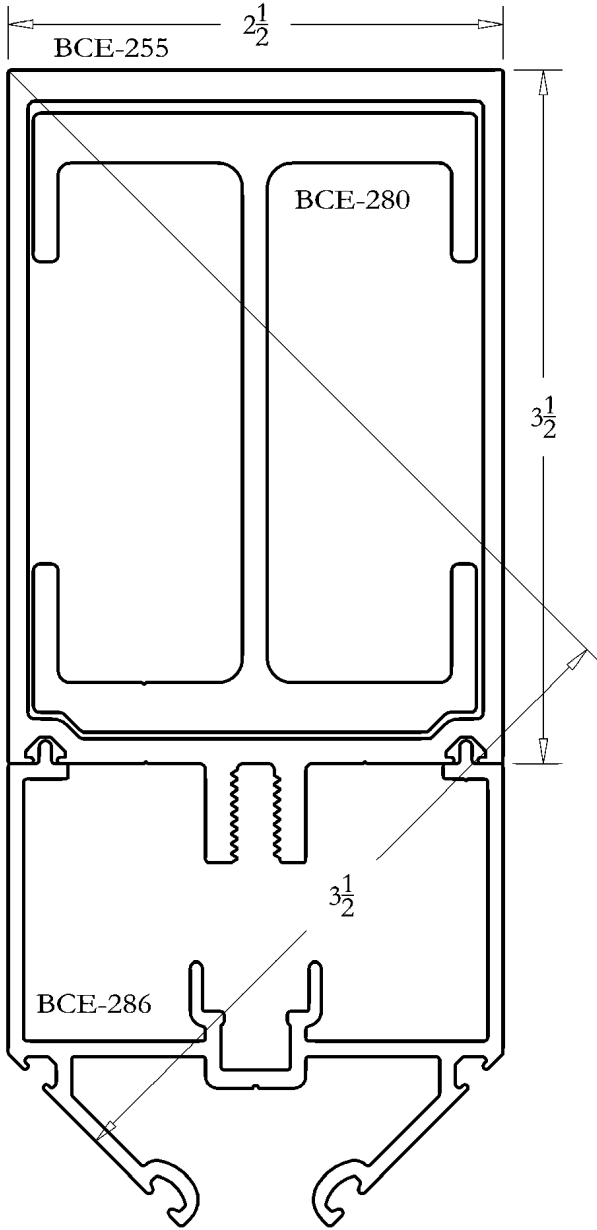



FULL SIZE DETAILS

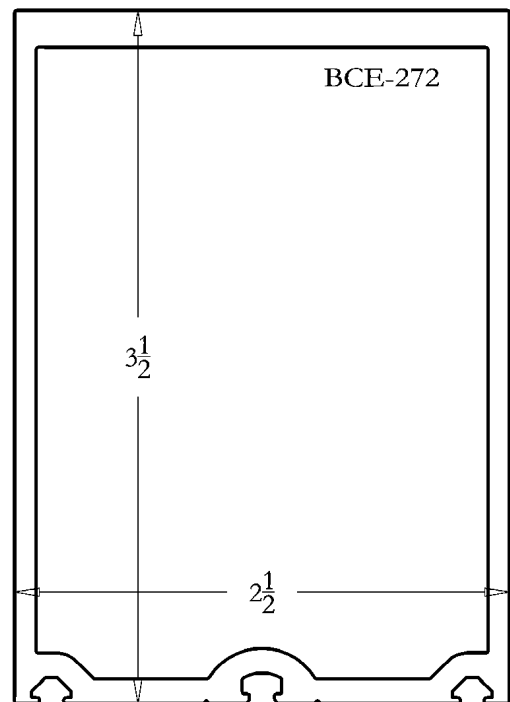
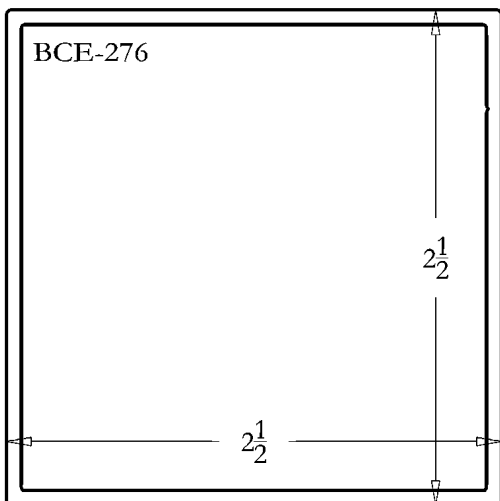
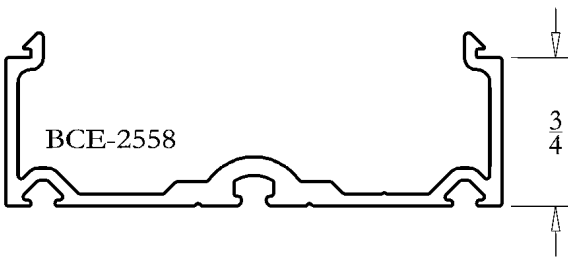
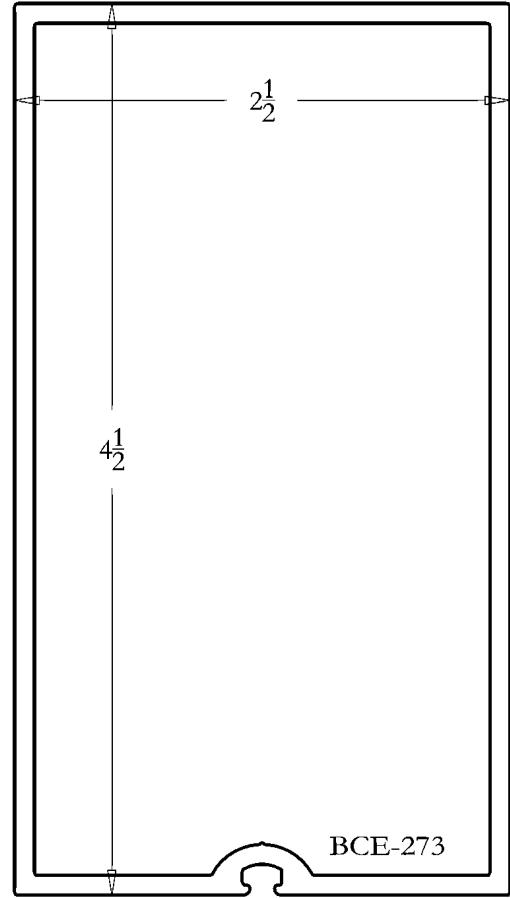
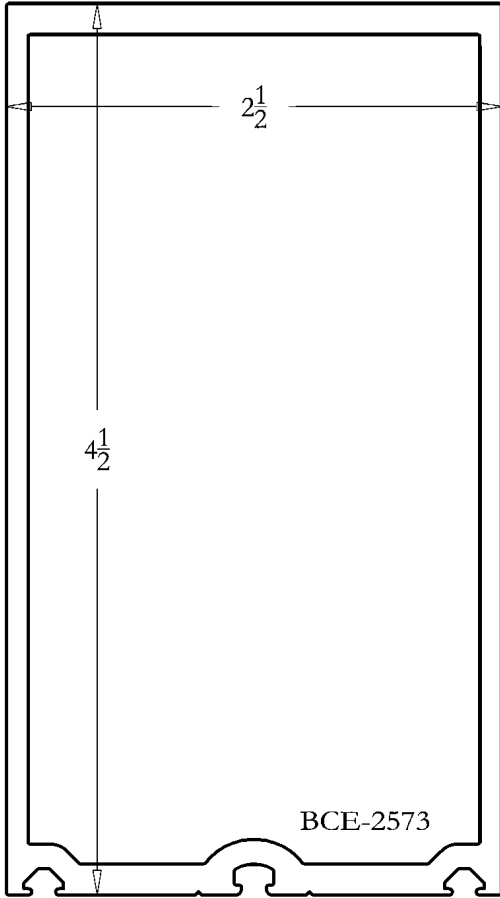

DETAIL SHEET
2 1/2" PRESSURE SYSTEM
BCE-250

FULL SIZE DETAILS

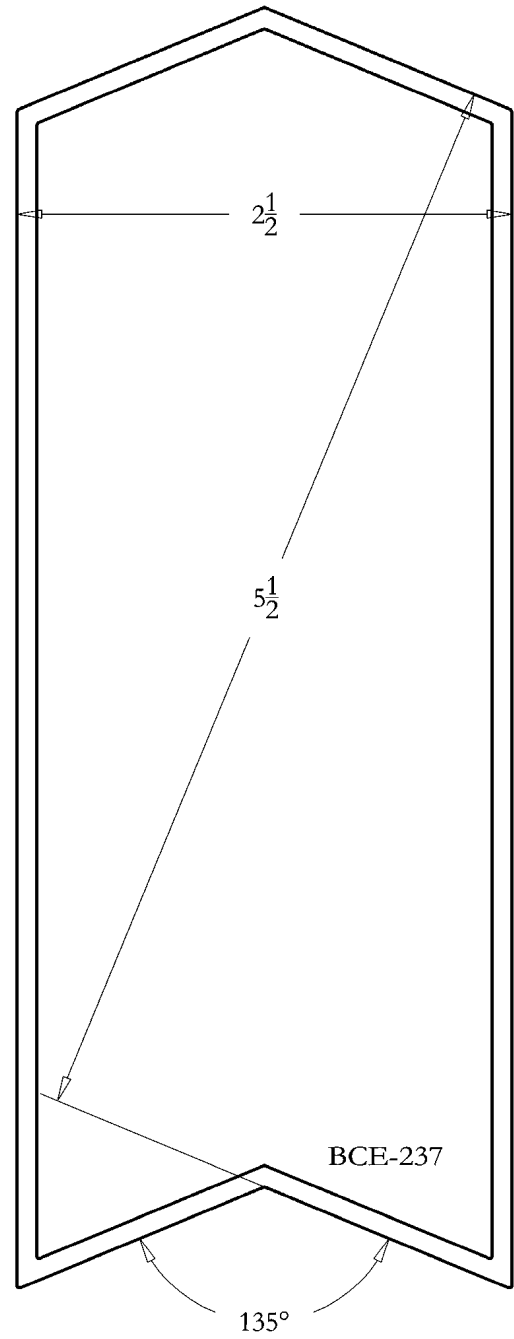
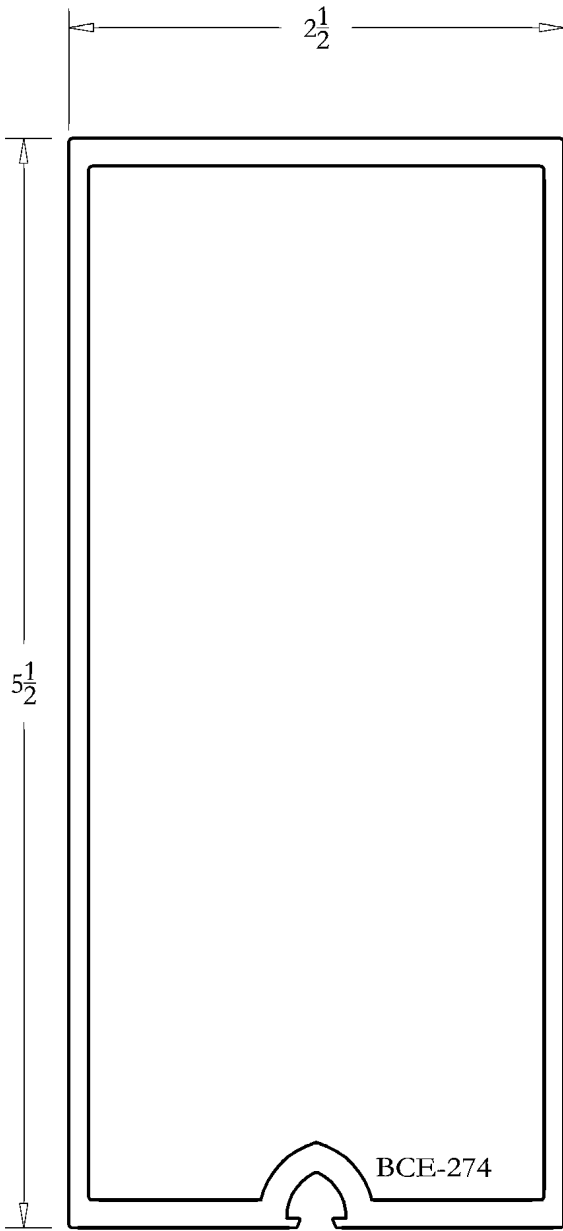

FULL SIZE DETAILS

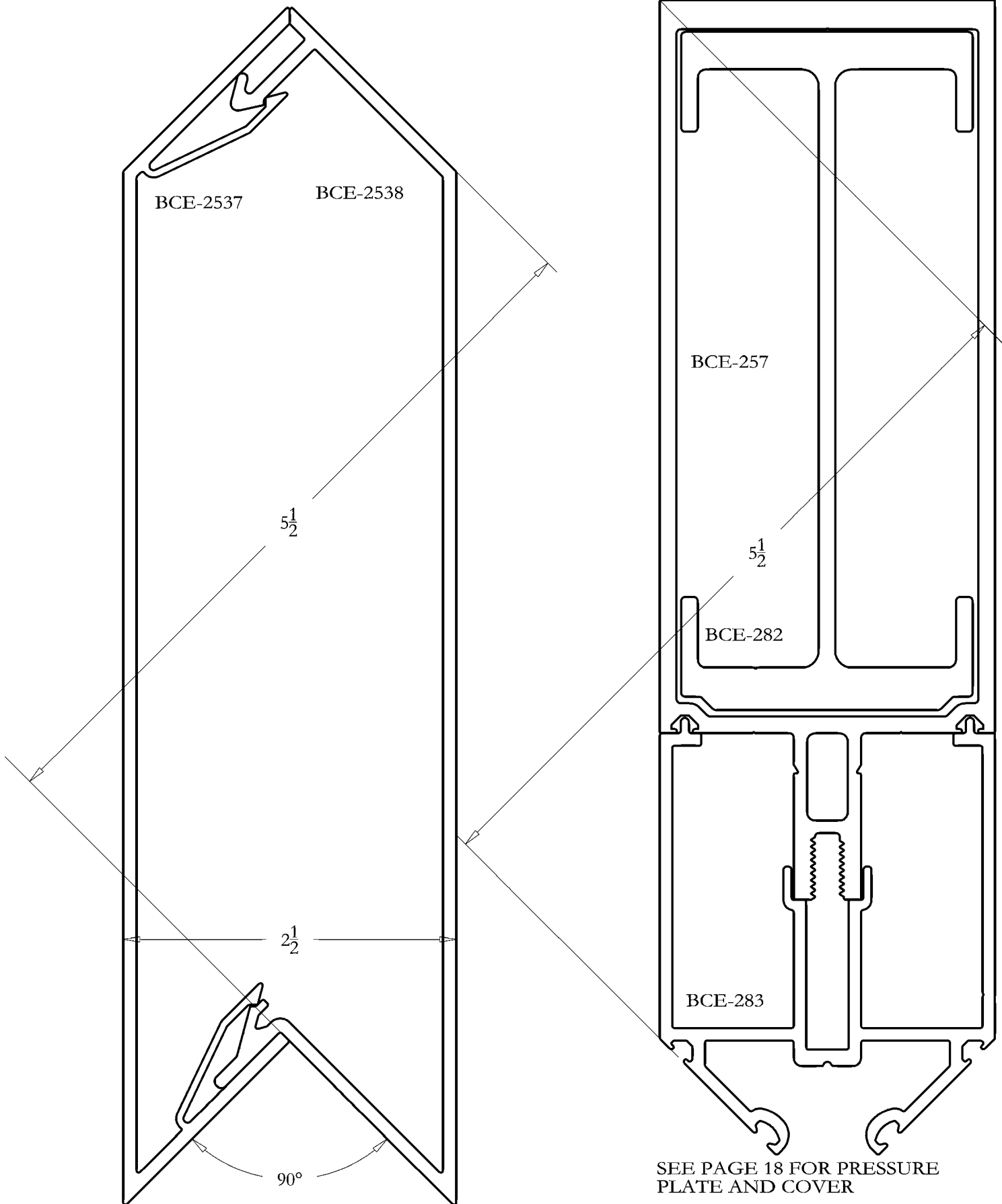

SEE PAGE 18 FOR PRESSURE
PLATE AND COVER

DETAIL SHEET
2 1/2" PRESSURE SYSTEM
BCE-250

FULL SIZE DETAILS

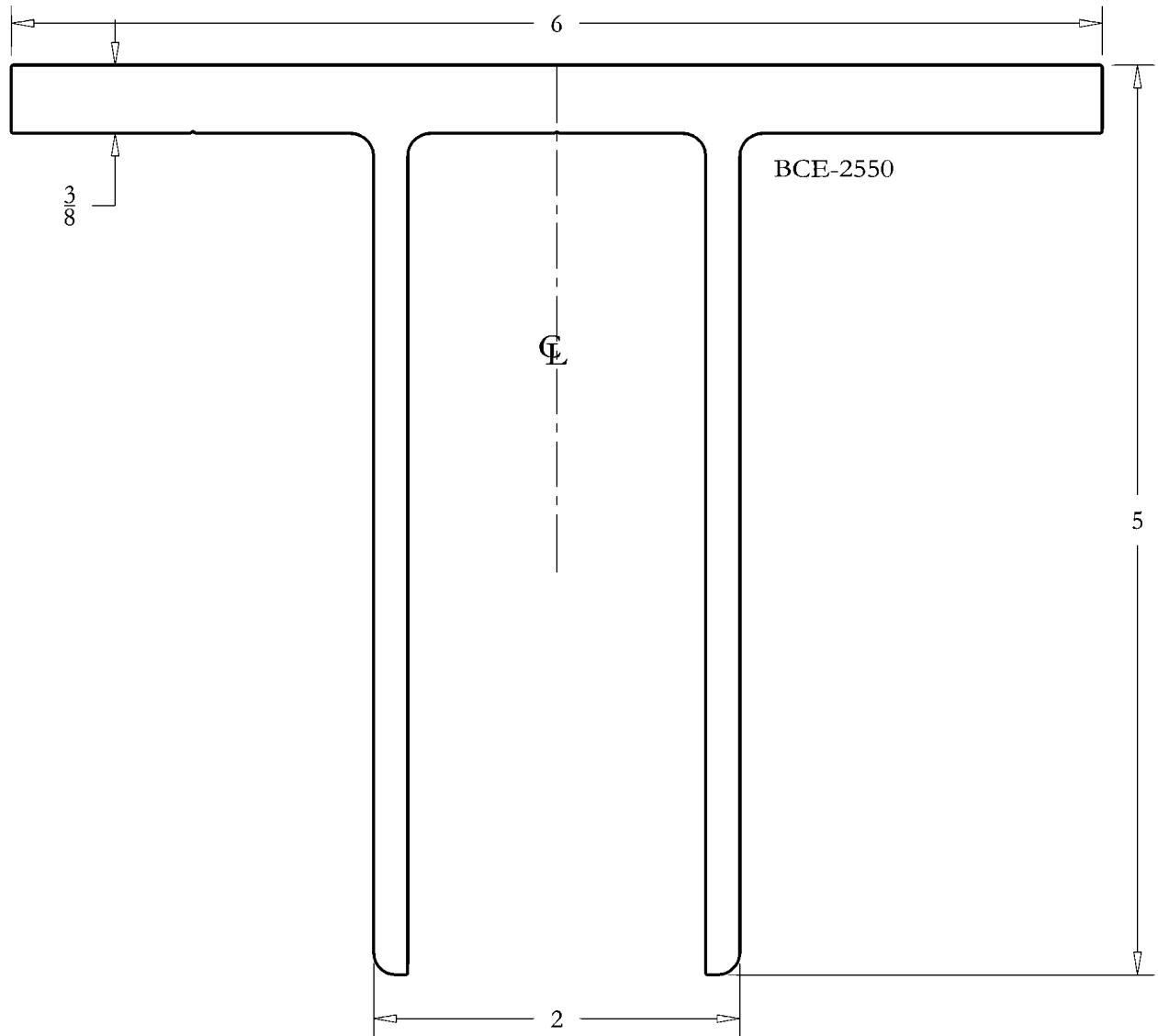
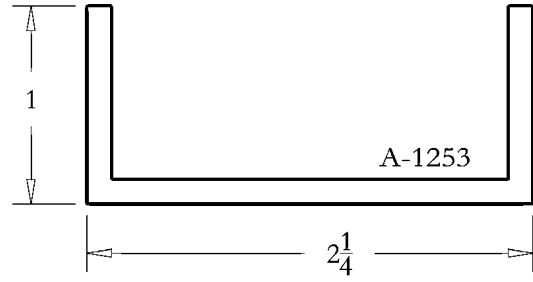
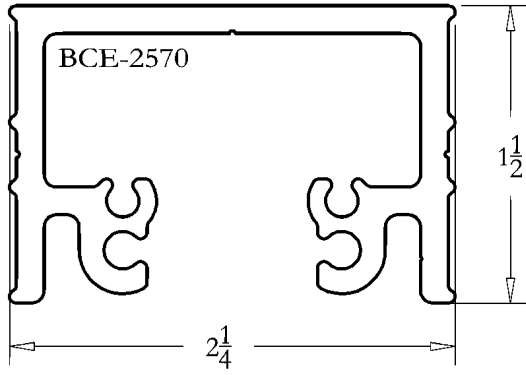

FULL SIZE DETAILS

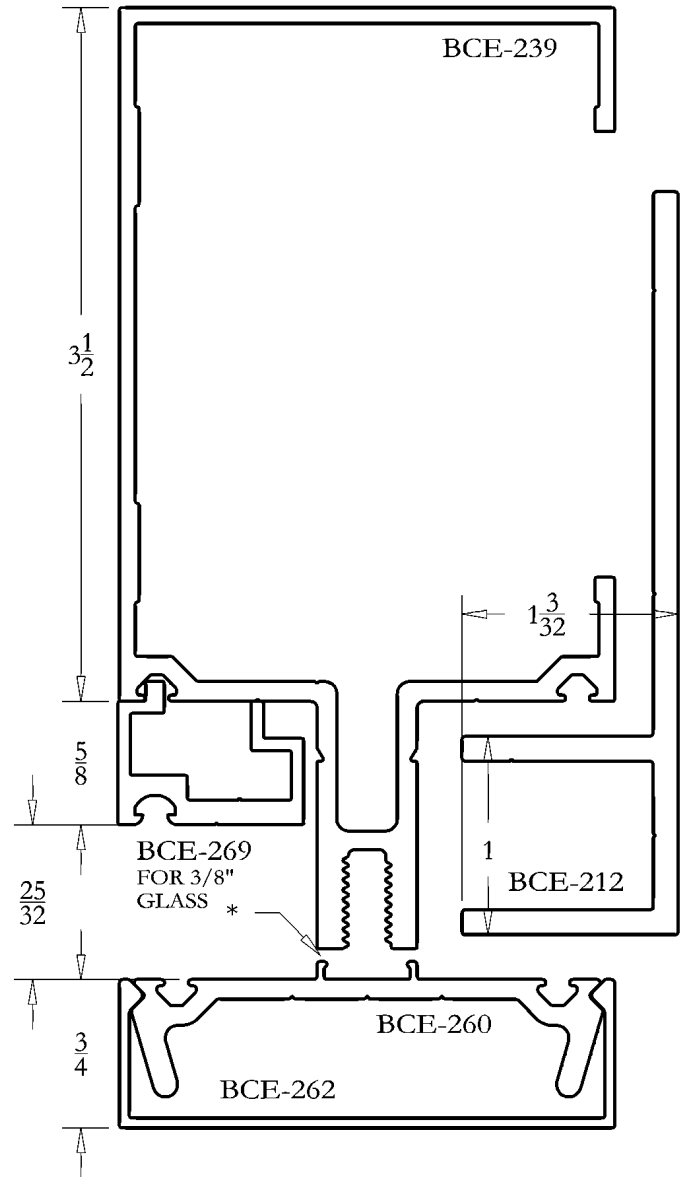
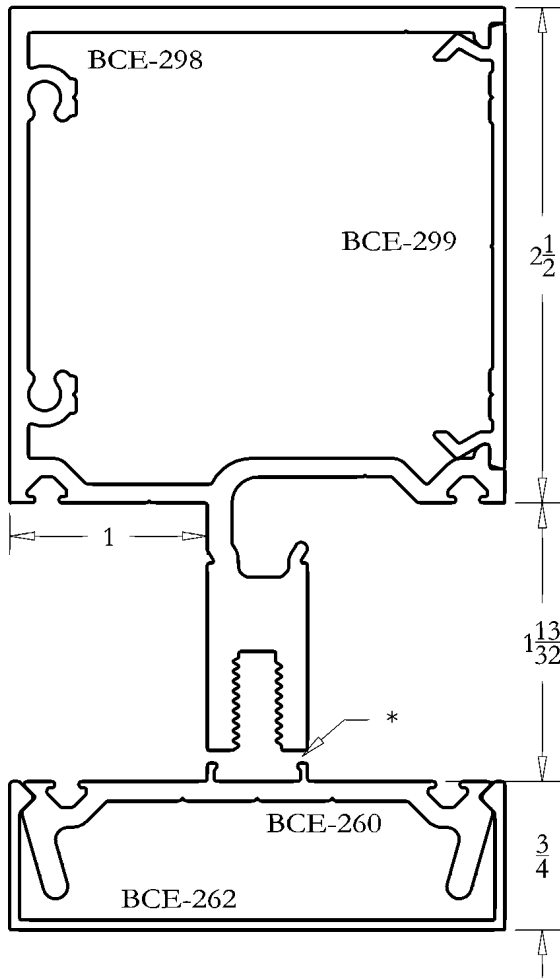
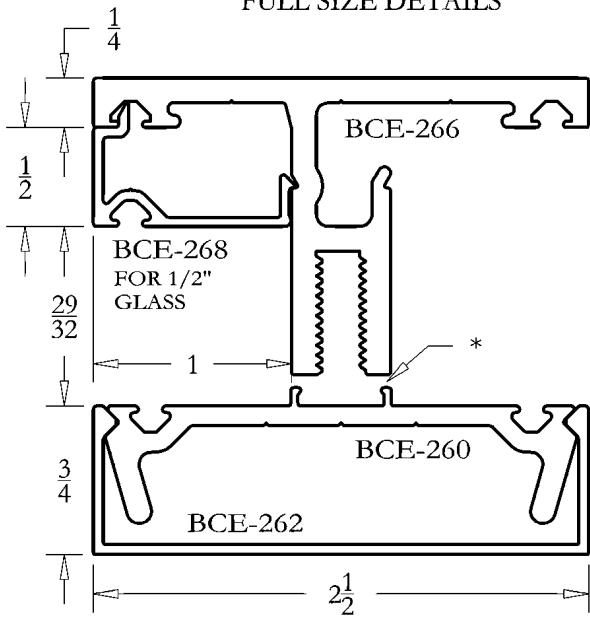

* RIGID VINYL SEPARATOR
SPECIFY SEPERATELY

FULL SIZE DETAILS

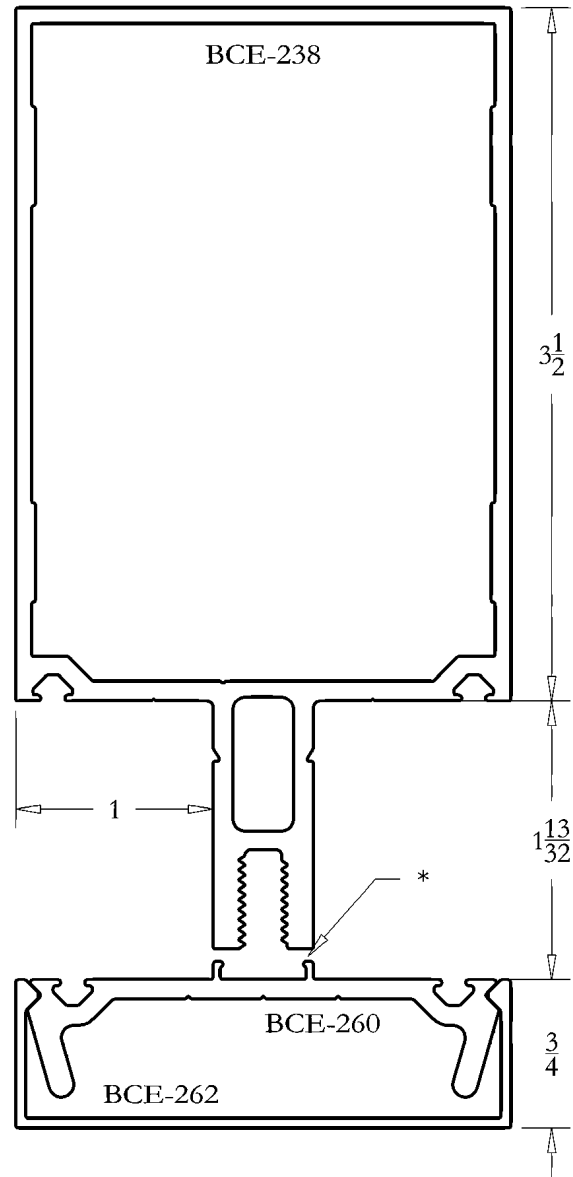
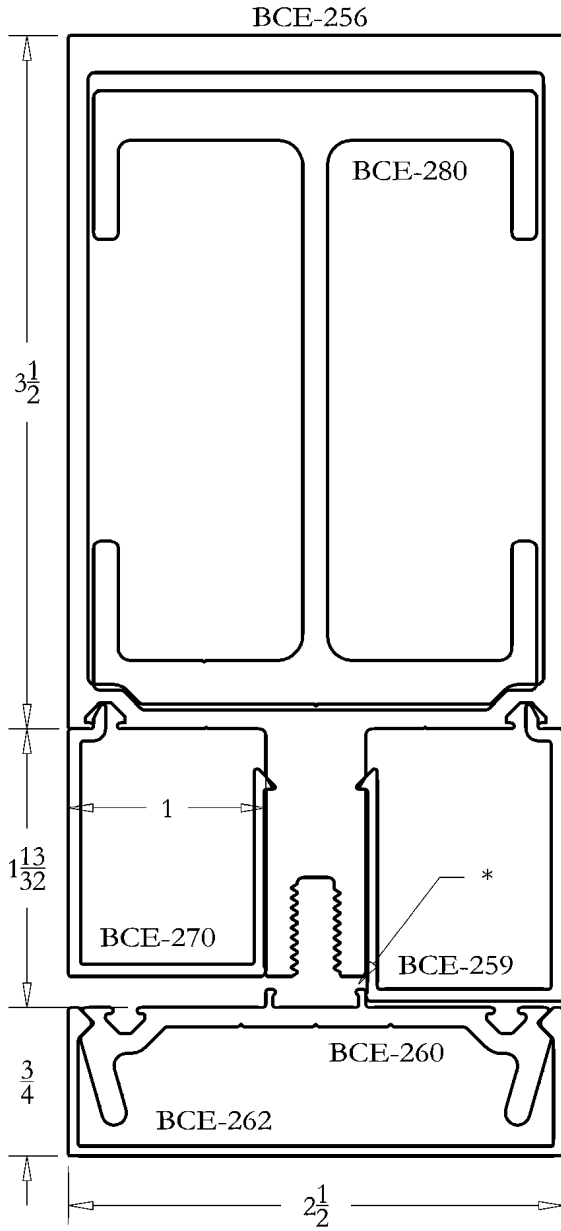

* RIGID VINYL SEPARATOR
SPECIFY SEPERATELY

FULL SIZE DETAILS

* RIGID VINYL SEPARATOR
SPECIFY SEPERATELY

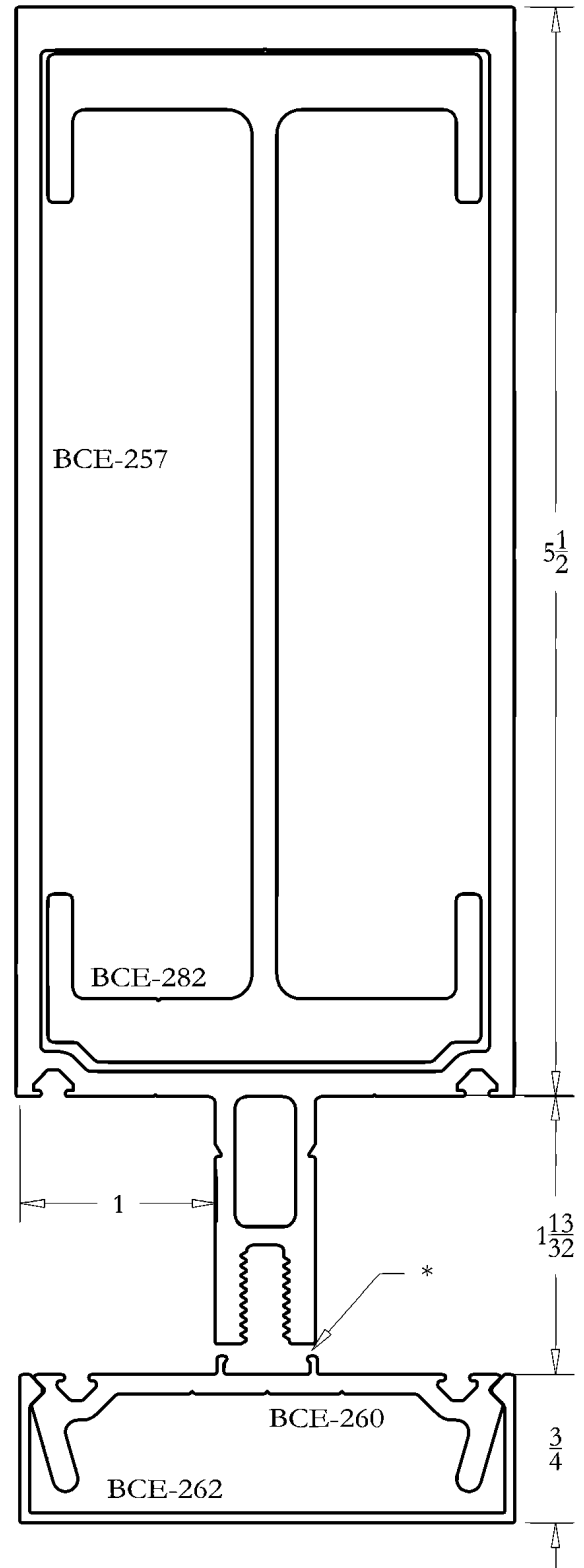
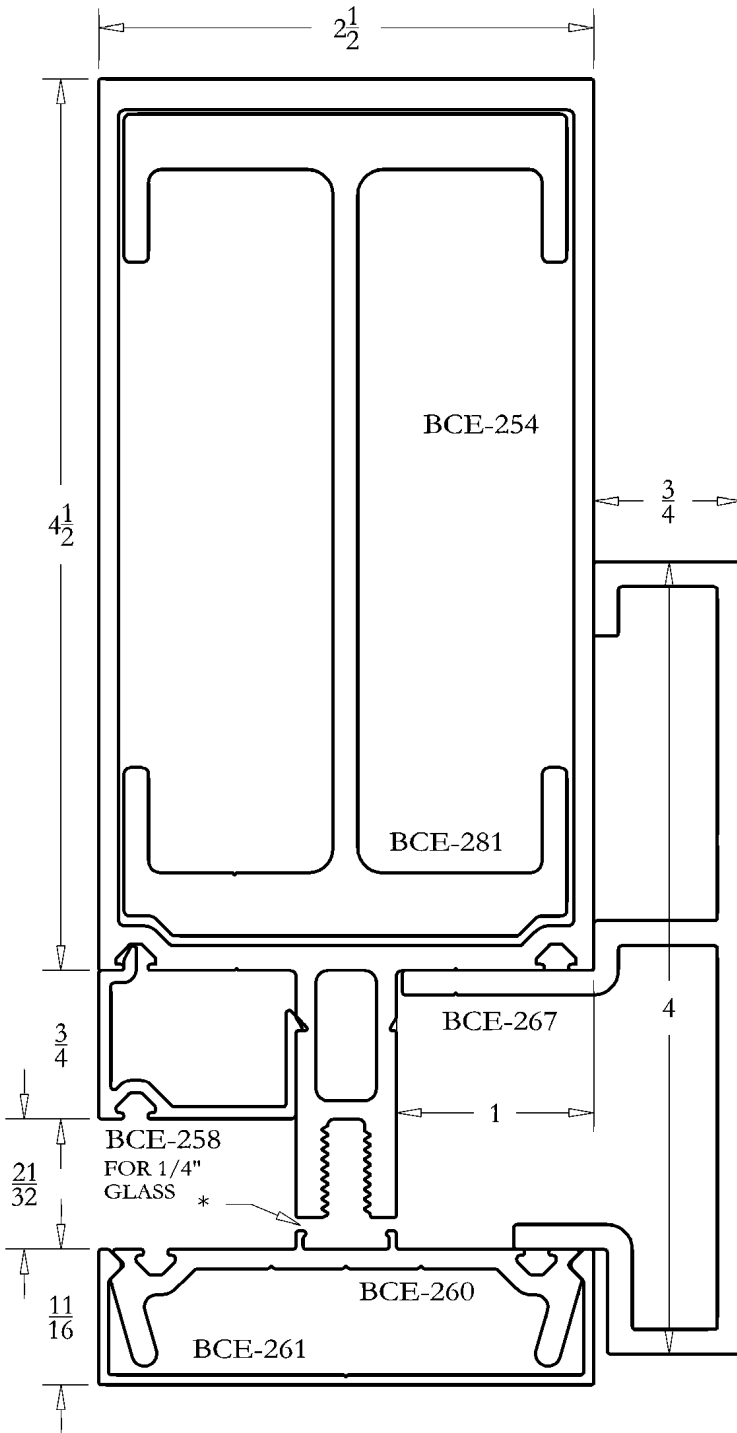

DETAIL SHEET
2 1/2" PRESSURE SYSTEM
BCE-250

FULL SIZE DETAILS

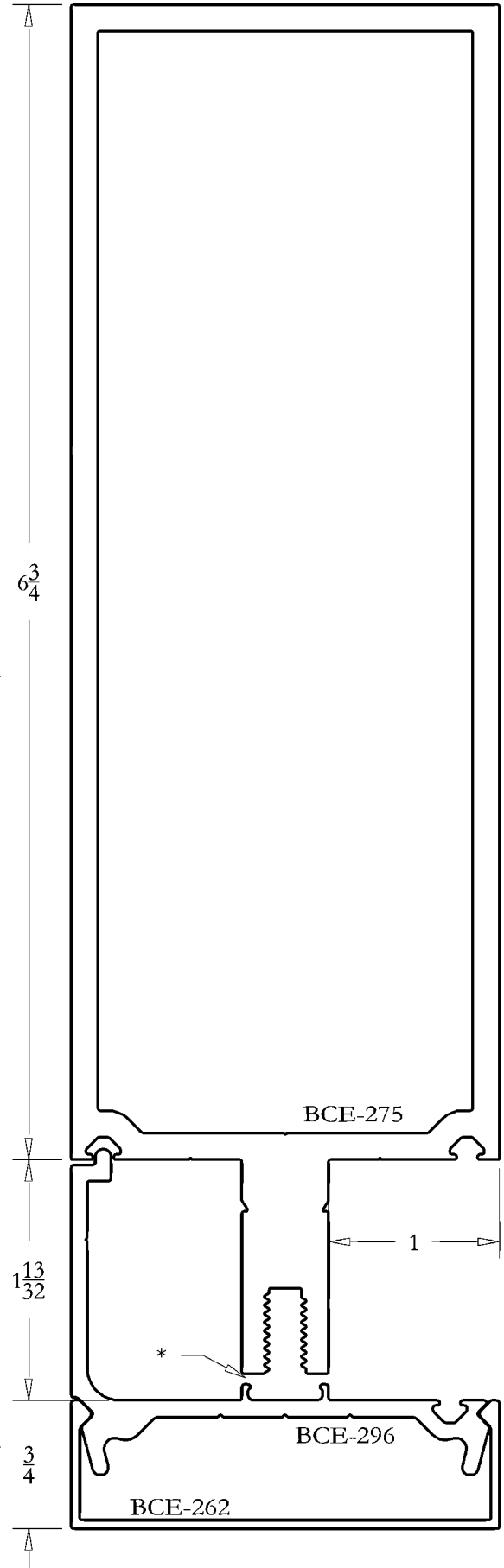
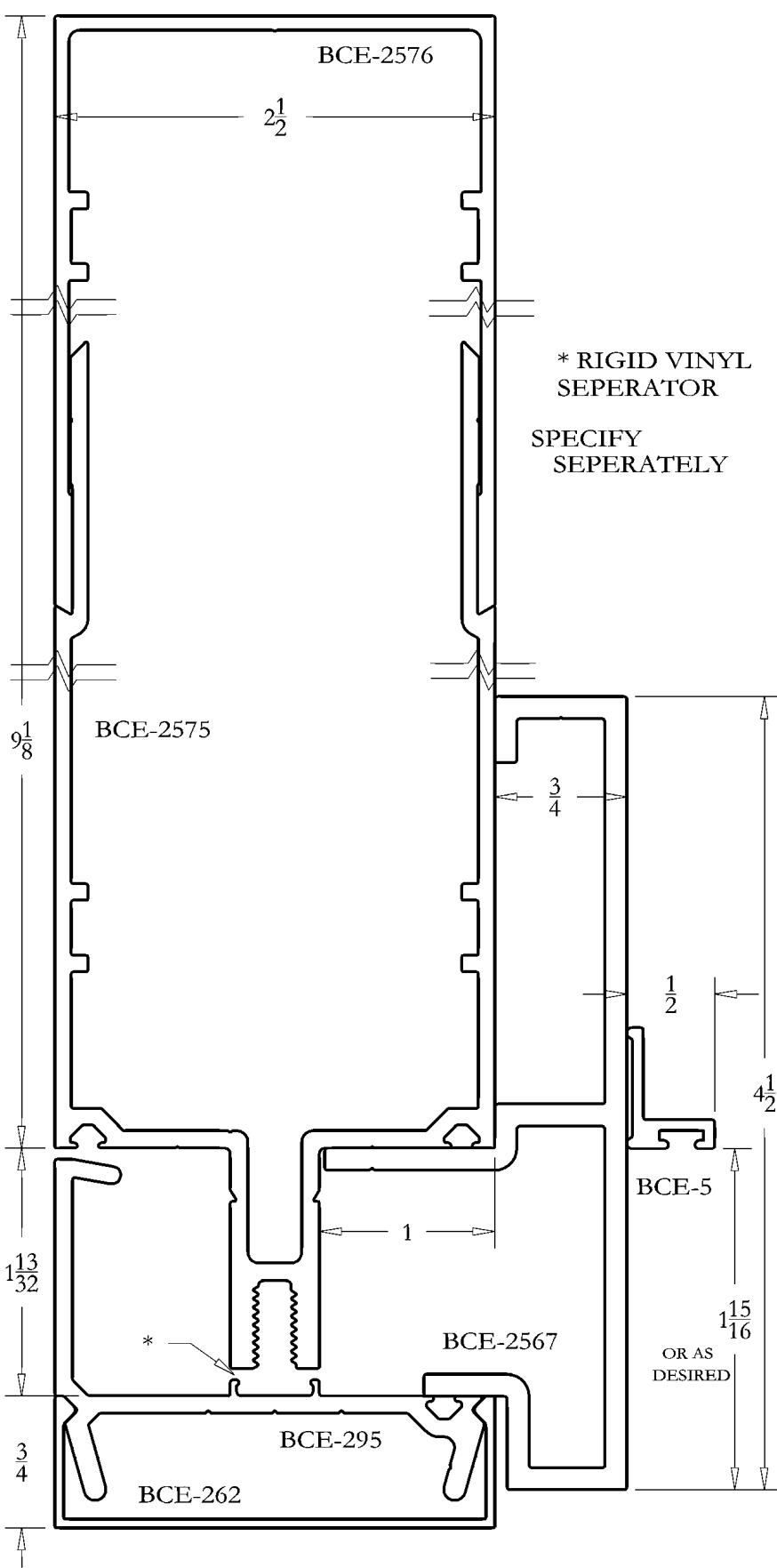



FULL SIZE DETAILS

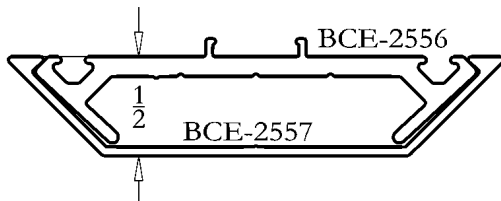
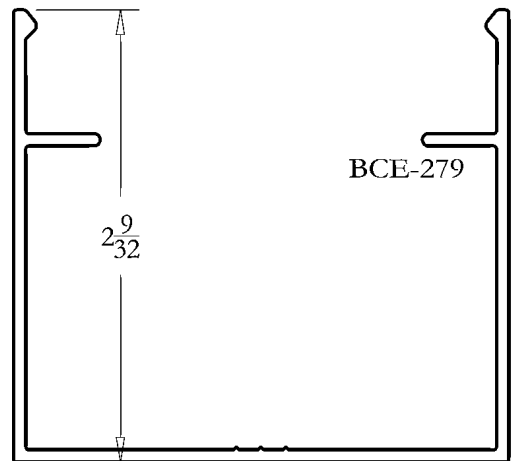
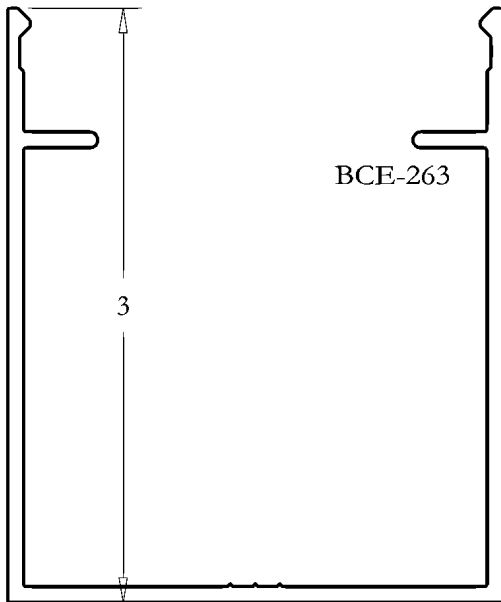
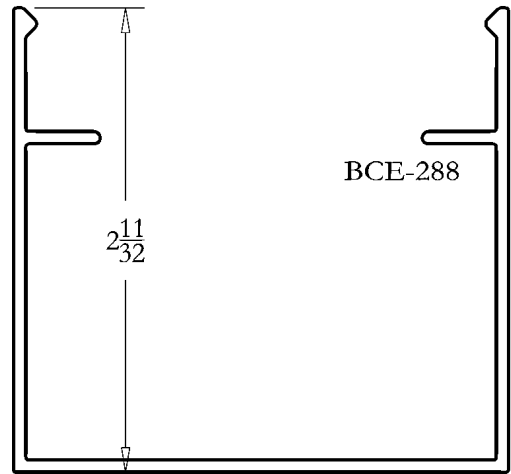
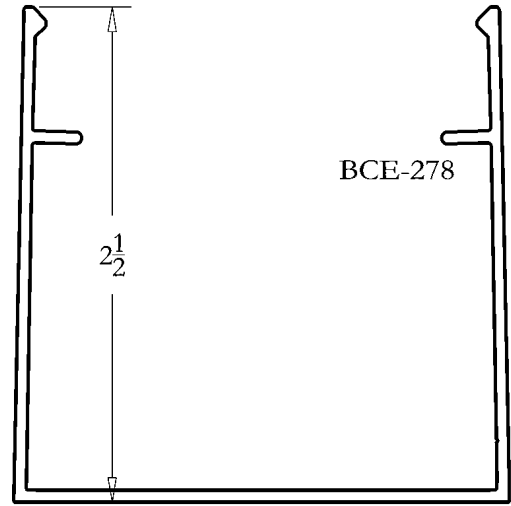
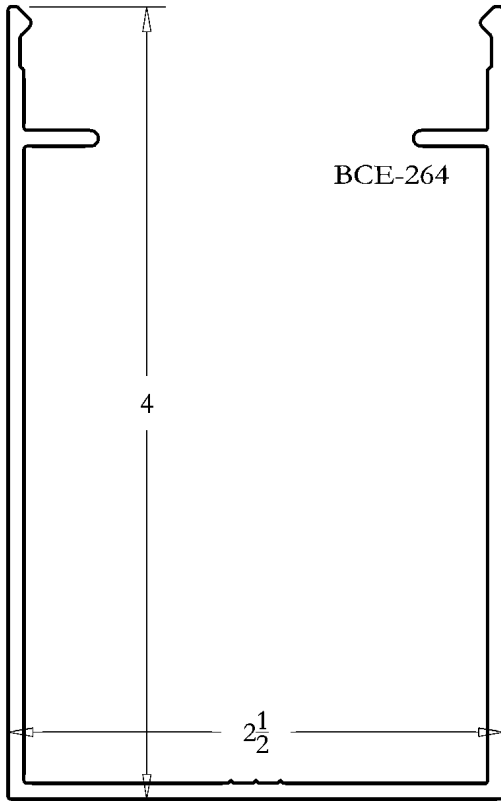

DETAIL SHEET
2 1/2" PRESSURE SYSTEM
BCE-250

FULL SIZE DETAILS

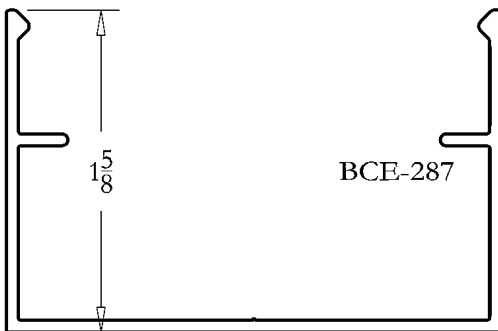
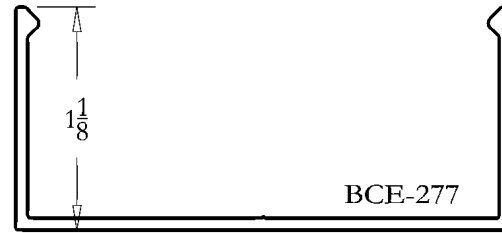
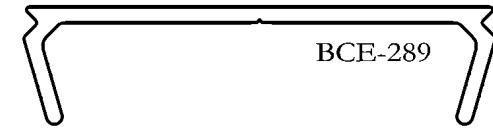
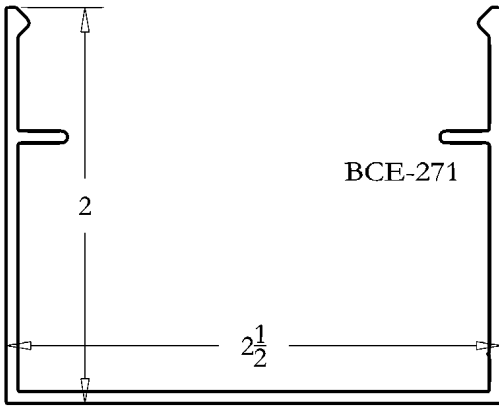

USE BCE-2560 & BCE-296
PRESSURE PLATES WITH
COVERS BCE-2561, BCE-2562
BCE-2563, & BCE-2564

